



AB Pal Electricals (P) Limited

Regd. Office: 1826, Bhagirath Palace, Chandni Chowk, Delhi-110006, India
Tel.: +91-11-43-111-333, 2386-5954, 3622, 4081, 8081, **Mob.:** +91-98914-98555
E-Mail: contact@abpal.com, **Website:** www.abpal.com



PRICE LIST

PROFESSIONAL LIGHTING SOLUTIONS

Crompton

Crompton Greaves Consumer Electricals Limited.,
Equinox Business Park, 1st Floor, Tower 3, LBS Marg, Kurla (W),
Mumbai 400070. Tel: +91 22 6167 8499 | www.crompton.co.in

Crompton



We are one of the leading consumer companies in India with a 90+ years old brand legacy. As of February 2016, we are an independent company under professional management and have 2 business segments – Lighting and Electrical Consumer Durables. We market our products under the “Crompton” brand name in India and select export markets.



Crompton is synonymous with quality, reliability and performance. Millions of Indians rely on Crompton products as they are robust, beautiful and being meticulously designed. It reflects the end consumer’s personality and lifestyle. Crompton strives to create aesthetically appealing styles with the highest quality standards.

“Once a Crompton consumer,
always a Crompton consumer.”

 <p>RELIABILITY</p>	 <p>PERFORMANCE</p>	 <p>QUALITY</p>
---	---	---

PROFESSIONAL LIGHTING

We have over 60 glorious years of operational experience. Our experience in the lighting industry is all thanks to our heavy investment in product testing and gathering data on consumer needs. We combine this knowledge with our technological leadership and have emerged as one of the top lighting players in the country. Our products are superior and advanced which is why we have become one of the most sought after brands in the lighting space.

Our offering in the B2B luminaire division is vast and varied. We provide tailor-made luminaire for every space. Our luminaires not only provide safety, but also bring the architectural wonder and grandeur of a particular space. Our luminaire solutions are truly multifaceted due to the nature of their operations.



INDOOR LIGHTING

RF Lighting | HCL Lighting | Linear Tiles | Downlights Decorative Suspended Batten | Cleanroom

INDUSTRIAL LIGHTING

LED Highbays | LED Wellglass LED Under Canopy | LED Bulk Head & Industrial Batten | Flameproof



OUTDOOR LIGHTING

Street Lighting | Flood Lighting Landscape Lighting

SOLAR LIGHTING

All-in-One Solar Street Light Stand Alone Solar Street Light



HIGH MAST AND POLES

High Mast | Octagonal Poles Decorative Poles | Brackets

MANUFACTURING PLANT

Crompton has state-of-the-art manufacturing plants that use only the latest technology in manufacturing every Crompton product. We work with the most brilliant minds to keep innovating and revolutionizing the lighting industry. Our manufacturing process is very thorough and detailed; we ensure that every product goes through a strict test before it reaches our beloved customers. Our manufacturing units are our strength and pride. Special mention to our ISO NABL certified plants at Baddi and Baroda that manufacture high intensity discharge lamps, general lighting service lamps, glass shells and much more. We have also received a DSRI certification for our robust in-house Research and Development Unit.



AWARD & CERTIFICATES



BRAND OF DECADE 2021-22 Consumer Electricals



NABL CERTIFICATION



“ ISO Certifications ”



FLAMEPROOF & TUNNEL LIGHTING CERTIFICATIONS

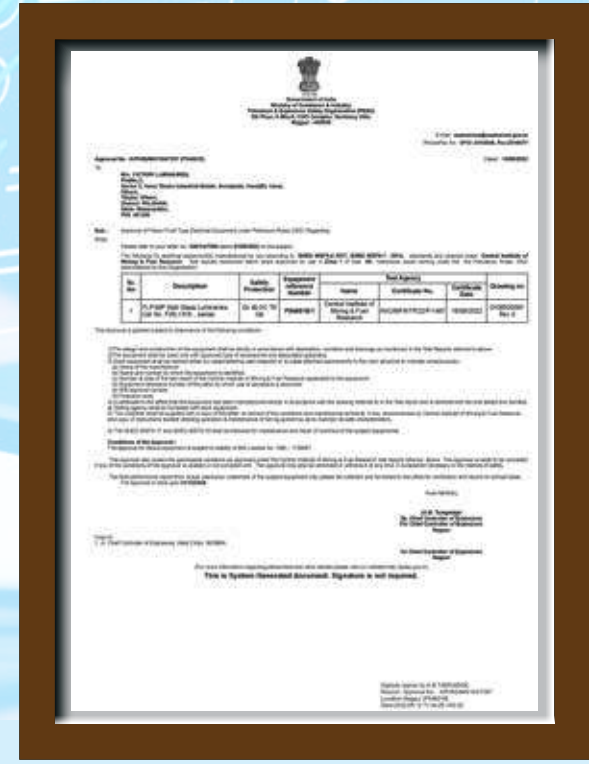

“ ISO Certifications ”



INNOVATIVE TECHNOLOGY

At Crompton, we brainstorm with the brightest minds and work together to develop the best lighting solutions for our customers. Our finished products are a reflection of our lighting knowledge which we refresh year upon year. This thinking has given birth to some innovative new lighting technologies.



CONNECTED LIGHTING

Group Dimming solution for Street Lighting

- ON/OFF Remote Control
- Real-time Report
- Reporting & Maintenance
- Lights Supporting Dimming

Connected lighting is a powerful lifestyle changing solution. It enhances efficiency by using data-driven insights. Crompton's lighting management software (LMS) can be accessed through a smart phone or a tablet that collects data from range of devices using Internet of Things.

This solution illuminates workspaces using information such as occupancy, temperature, air quality and energy consumption. Every luminaire acts as a communicating node. It does more than just light up a workspace; it acts as the backbone of smart infrastructure.



HUMAN CENTRIC LIGHTING FOR INDOOR SPACES

Crompton understands the importance of personal well being, as it is linked to their productivity level. Human centric lighting essentially changes the CCT (Correlated Color Temperature) depending on the time of day and the lighting changes from a soothing dim to an alert bright, whereby soothing the eyes, improving work efficiency and concentration levels. In other words, it mimics natural daylight. Therefore, this solution is apt for an office having low natural light or offices where work happens at night.

Lighting should match Body's Circadian Rhythm



Lights automatically adjust their CCT according to the time of day



Light connected to each other via Bluetooth



06:00 ^{am}
2700K

10:00 ^{am}
4300K

12:00 ^{pm}
6500K

02:00 ^{pm}
4300K

06:00 ^{pm}
2700K



RF CONNECTED LIGHTING FOR INDOOR SPACES

RF lighting control uses a two-way radio frequency transmission to communicate with one another. There is no requirement of wiring or traditional switches or dimmers. Sensors are integrated with fixtures or even standalone. It is an economical effective lighting solution for large office spaces. The effective remote control and monitoring can handle any type of lighting from basic dimming control to light fades. It incorporates a web based IoT lighting control solution.

Completely Wireless Control Solution



Lights with Integrated Sensors and Communication



Finer Facility Management



Collect Building Occupancy & Temperature Data



Additional Energy Savings



16-31
Indoor
Lighting



34-43
Industrial
Lighting



32-33
Cleanroom
Lighting



44-45
Flameproof
Lighting



46-53
Street
Lighting



54-59
Flood
Lighting



60-63
Landscape
Lighting



64-69
Solar
Lighting



70-83
Highmast &
Decorative Poles





RF LIGHTING

Intelligent, intuitive, and energy efficient lighting solution for office space that does more than just light up the workspace - it acts as a backbone for smart office/building. Our products, complete with human machine interface, can help any office adapt to its occupancy while bringing efficiency in every operation. Its robust IoT architecture provides for flexible & reliable control, energy management, space utilization inputs & easy integration with BMS - that too Wirelessly.

VOGUE RF

CAT. REF.	CASE LOT	MRP (₹)
CCP-121-28-WW-SL-RF-DP-WWH	1	on request
CCP-121-28-TL-SL-RF-DP-WWH	1	on request
CCP-121-28-CDL-SL-RF-DP-WWH	1	on request

POLARIS RF

CAT. REF.	CASE LOT	MRP (₹)
CCR-143-36-WW-SL-RF-DP-WWH	1	on request
CCR-143-36-TL-SL-RF-DP-WWH	1	on request
CCR-143-36-CDL-SL-RF-DP-WWH	1	on request

STYLO RF

CAT. REF.	CASE LOT	MRP (₹)
CDR-218-12-WW-RF-DP-WWH	1	on request
CDR-218-12-TL-RF-DP-WWH	1	on request
CDR-218-12-CDL-RF-DP-WWH	1	on request
CDR-218-15-WW-RF-DP-WWH	1	on request
CDR-218-15-TL-RF-DP-WWH	1	on request
CDR-218-15-CDL-RF-DP-WWH	1	on request
CDR-218-18-WW-RF-DP-WWH	1	on request
CDR-218-18-TL-RF-DP-WWH	1	on request
CDR-218-18-CDL-RF-DP-WWH	1	on request



Indoor lighting



HCL LIGHTING

Human Centric Lighting (or HCL) is key to maintaining high productivity levels in enclosed offices, especially when they operate 24x7. Our HCL products provide for wirelessly connected & controlled office lighting which is easy to operate & control. This unique lighting solution mimics natural sunlight, is dimmable & helps improve work efficiency.

VOGUE HCL

CAT. REF.	CASE LOT	MRP (₹)
CCP-133-40-HCL-SL-BT-DWH	1	on request

STELLUX-I HCL

CAT. REF.	CASE LOT	MRP (₹)
CCR-130-30-HCL-SL-BT-DWH	1	on request

STELLUX-P HCL

CAT. REF.	CASE LOT	MRP (₹)
CCR-131-30-HCL-SL-BT-DWH	1	on request

STYLO-O HCL

CAT. REF.	CASE LOT	MRP (₹)
CCR-130-30-HCL-SL-BT-DWH	1	on request



LINEAR

Crompton Linear Lights have the flexibility and freedom to design the lighting of your workplace any way you deem fit. Turn your office into a modern vibrant space that is tuned to your aesthetic senses. Put together patterns to your liking with lengths of lights that you need. Linear lights are also available in high efficiency (upto 140lm/W), UGR & up-down versions.

VOGUE

CAT. REF.	CASE LOT	MRP (₹)
CCP-121-18-WW/TL/CDL-SL-NWH	4	8850
CCP-121-24-WW/TL/CDL-SL-NWH	4	9440
CCP-121-28-WW/TL/CDL-SL-NWH	4	10030

TRENDZ

CAT. REF.	CASE LOT	MRP (₹)
CCP-143-24-WW/TL/CDL-SL-NWH	8	7700
CCP-143-28-WW/TL/CDL-SL-NWH	8	7700
CCP-143-36-WW/TL/CDL-SL-NWH	8	7700

VOGUE CONNECTOR

CAT. REF.	CASE LOT	MRP (₹)
CONNECTOR - L	1	On Request
CONNECTOR - T	1	On Request
CONNECTOR - X	1	On Request
CONNECTOR - Y	1	On Request

TREND

CAT. REF.	CASE LOT	MRP (₹)
LCLR66-30-WW/TL/CDL	6	8850
LCLR66-36-WW/TL/CDL	6	8850
LCLR90-36-WW/TL/CDL	6	10030

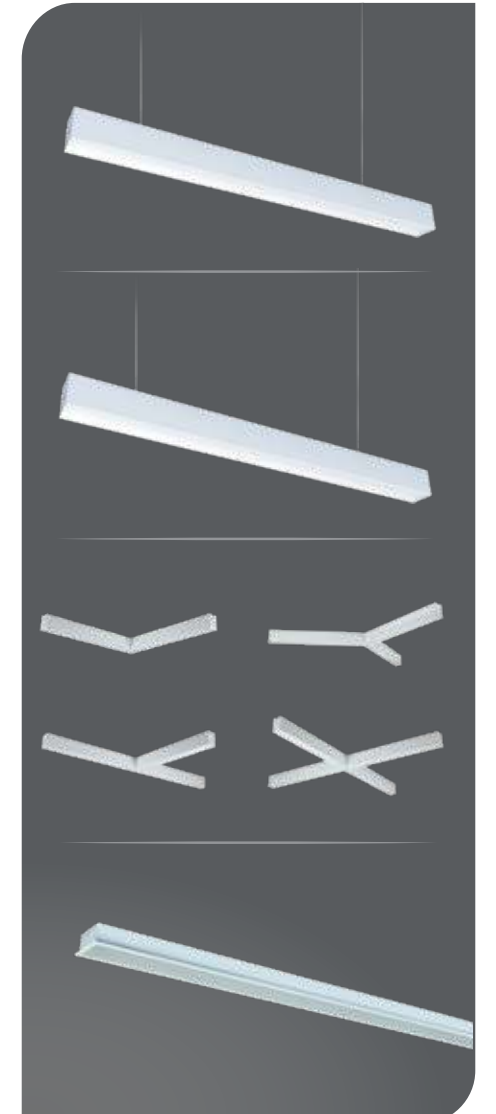



TILES

SIGNATURE SERIES

Stellux series signature tiles bring together superior performance with unique style features. It is LG7 compliant luminaire with UGR<19 & high performance LED driver. Suitable for cabin, board rooms & VIP areas.

STELLUX-S

CAT. REF.	CASE LOT	MRP (₹)
LCTRS-36-WW	1	8260
LCTRS-36-TL	1	8260
LCTRS-36-CDL	1	8260

STELLUX-P

CAT. REF.	CASE LOT	MRP (₹)
LCTRP-36-WW	1	7200
LCTRP-36-TL	1	7200
LCTRP-36-CDL	1	7200

STELLUX-H

CAT. REF.	CASE LOT	MRP (₹)
LCTRH-36-WW	1	12510
LCTRH-36-TL	1	12510
LCTRH-36-CDL	1	12510

STELLUX-I

CAT. REF.	CASE LOT	MRP (₹)
LCTRI-36-WW	1	7080
LCTRI-36-TL	1	7080
LCTRI-36-CDL	1	7080



VECTOR SERIES

Vector series tiles allow you to create beautiful pattern on your ceiling. Seamless integration with ceiling, easy maintenance, high system efficacy makes it a hassle free choice for office spaces. Select from any of our 7 unique design alongwith 3 CCT options & convert your ceiling into a beautiful piece of art. Product image with illustration of 4 is shown for reference.

VECTOR I

Multi angular design - Geometrically aligned - can be arrange symmetrically or abstract

CAT. REF.	CASE LOT	MRP (₹)
LCTLRF1-36-WW	2	7080
LCTLRF1-36-TL	2	7080
LCTLRF1-36-CDL	2	7080

VECTOR II

Merged octagon design - Geometrically aligned - can be arrange symmetrically or abstract

CAT. REF.	CASE LOT	MRP (₹)
LCTLRF2-36-WW	2	7080
LCTLRF2-36-TL	2	7080
LCTLRF2-36-CDL	2	7080

VECTOR III

Tri angular design - Geometrically aligned - can be arrange symmetrically or abstract

CAT. REF.	CASE LOT	MRP (₹)
LCTLRF3-36-WW	2	7080
LCTLRF3-36-TL	2	7080
LCTLRF3-36-CDL	2	7080

VECTOR IV

Abstract design - Geometrically aligned - can be arrange symmetrically or abstract.

CAT. REF.	CASE LOT	MRP (₹)
LCTLRF4-36-WW	2	7080
LCTLRF4-36-TL	2	7080
LCTLRF4-36-CDL	2	7080

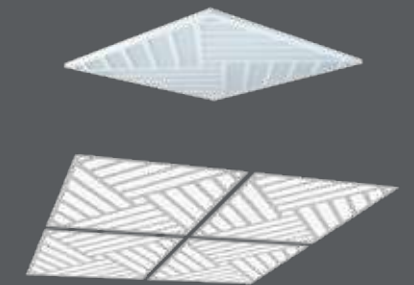

VECTOR I (ILLUSTRATION OF 4)

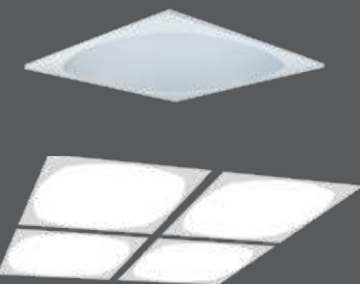

VECTOR II (ILLUSTRATION OF 4)

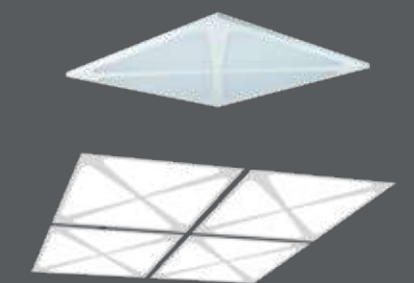

VECTOR III (ILLUSTRATION OF 4)

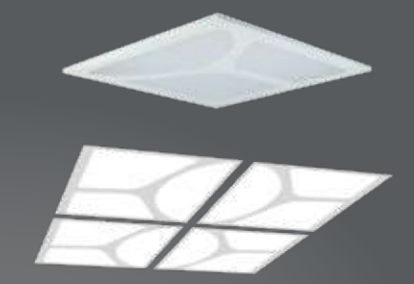

VECTOR IV (ILLUSTRATION OF 4)

VECTOR V

Abstract design - Geometrically aligned - can be arrange symmetrically or abstract

CAT. REF.	CASE LOT	MRP (₹)
LCTLRF5-36-WW	2	7080
LCTLRF5-36-TL	2	7080
LCTLRF5-36-CDL	2	7080

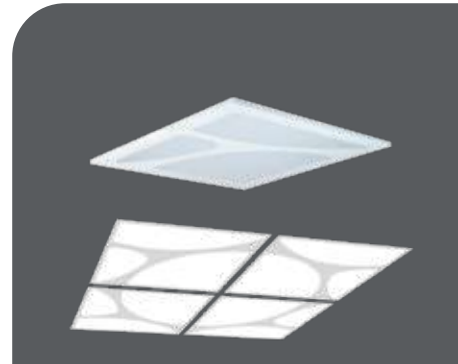

VECTOR V (ILLUSTRATION OF 4)

VECTOR VI

Rhombus design - Geometrically aligned - can be arrange symmetrically or abstract

CAT. REF.	CASE LOT	MRP (₹)
LCTLRF6-36-WW	2	7080
LCTLRF6-36-TL	2	7080
LCTLRF6-36-CDL	2	7080

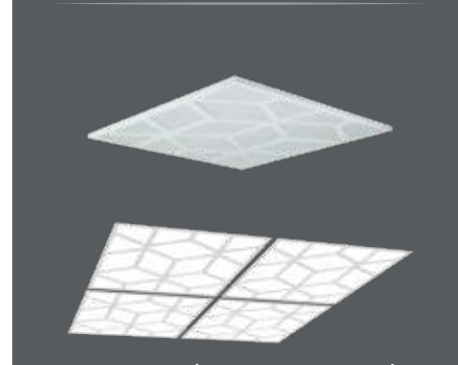

VECTOR VI (ILLUSTRATION OF 4)

VECTOR VII

Square design - Geometrically aligned - can be arrange symmetrically or abstract

CAT. REF.	CASE LOT	MRP (₹)
LCTLRF7-36-WW	2	7080
LCTLRF7-36-TL	2	7080
LCTLRF7-36-CDL	2	7080



VECTOR VII (ILLUSTRATION OF 4)



POLLUX

Pollux is a exquisitely designed luminaire which is bound to deliver extra ordinary lumens through its pure form and glare-less light. Recessed full open 2x2 (>120 lm/W).

CAT. REF.	CASE LOT	MRP (₹)
LCTLRP-24-FO-CDL	2	7080
LCTLRP-30-FO-CDL	2	7670
LCTLRP-36-FO-CDL	2	8260



POLARIS NIO I-II

LED Recessed full lit luminaire with glare free uniform illumination with longer life and less maintenance. Available in 2x2 Ft (>100 lm/W). Also available in warm white and natural white

CAT. REF.	CASE LOT	MRP (₹)
LCTLRNE-18-CDL(1X1)	4	2750
LCTLRNE-24-CDL(1X1)	4	3900
LCTLRNE-24-FO-CDL	2	5310
LCTLRNE-30-FO-CDL	2	5670
LCTLRNE-36-FO-CDL	2	5900
LCTLRNE-42-FO-CDL	2	6500
CCR-126-50-57-SL-NWH	2	7080



POLARIS NIO - III

Surface mounted full lit luminaire with uniform illumination. Long life & less maintenance, 18W & 24W are available in both 1ft x1ft & 2ftx2ft size. Also available in warm white and natural white

CAT. REF.	CASE LOT	MRP (₹)
LCTLSNE-18-FO-CDL (1x1)	4	3540
LCTLSNE-24-FO-CDL (1x1)	4	4130
LCTLSNE-24-FO-CDL	2	5900
LCTLSNE-30-FO-CDL	2	6490
LCTLSNE-36-FO-CDL	2	7080
LCTLSNE-40-FO-CDL	2	7650



POLARIS (T)

Ultra-low depth & light weight full lit luminaire with uniform illumination. Available in 36W with L bracket/spring clamps option

CAT. REF.	CASE LOT	MRP (₹)
TCR-145-36-65-SL-NWH	6	5300
TCR-145-36-57-SL-NWH	6	5300



KINETIC

Crompton KINETIC comes with integrated motion sensor. This luminaire is suitable for 600x600 mm ceiling & recommended for modern offices, auditorium, assembly hall & other commercial interiors where sensor based On/Off function is required. Lights are turned ON as soon as motion is detected and turned off after a 'Configurable Time'

CAT. REF.	CASE LOT	MRP (₹)
LCTLRNM-36-FO-CDL	1	on request



SPAN

Span is recessed and surface LED 1x4 Ft Panel ceiling light with high performance, commercial grade solution suitable for hospitals, schools, offices and so much more. (>100 lm/W). Also available in warm white and natural white.

CAT. REF.	CASE LOT	MRP (₹)
LCTLRNE-40-CDL(1X4)	2	7080
LCTLSNE-40-CDL(1X4)	2	7670

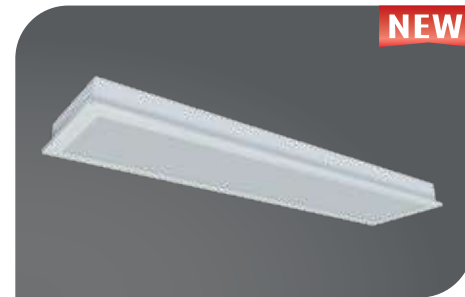

TECHZONE

Designed with simplicity and attention to detail in mind. This luminaire is perfect for 150 mm recess techzone ceiling. Also available in warm white and natural white.

CAT. REF.	CASE LOT	MRP (₹)
LCRTTZN-40-CDL	2	9680

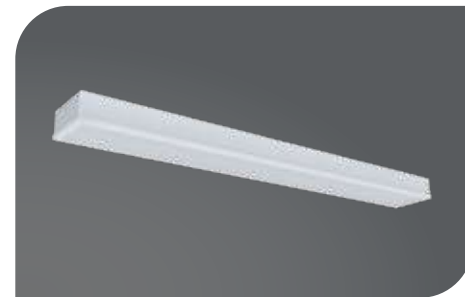

DOWNLIGHTS

ORBIT

Orbit LED cylinders employ the same quality lighting and design configuration to ensure consistent colour point between luminaires within a lighting application. Available in Black and White colour option in 3000K, 4000K and 5700K CCT. Beam angle 36 degree.

CAT. REF.	CASE LOT	MRP (₹)
CDS-201-15-57-HL2-NWH	1	5310
CDS-201-20-57-HL2-NWH	1	5550
CDS-200-25-57-SL-NWH	1	8030
CDS-200-30-57-SL-NWH	1	8500



FAME SPOT

New series of LED Spot Light specially designed for commercial usage Long life with 30000 burning hours with CRI >80. Wide range of choices available from 3w upto 50w. available in 3000K and 4000K. Beam angle 36 degree, Vertical Tilt 30 degree.

CAT. REF.	CASE LOT	MRP (₹)
CDR-210-03-30/40-SL-NWH	20	890
CDR-211-06-30/40-SL-NWH	20	1180
CDR-211-09-30/40-SL-NWH	12	1710
CDR-212-12-30/40-SL-NWH	12	1830
CDR-212-15-30/40-SL-NWH	12	2720
CDR-213-18-30/40-SL-NWH	12	2840
CDR-213-24-30/40-SL-NWH	12	3430
CDR-213-24-30/40-SL-NWH	12	3430
CDR-214-30-30/40-SL-NWH	12	4490
CDR-215-40-30/40-SL-NWH	8	6020
CDR-215-50-30/40-SL-NWH	8	6260



DLYT

First of its kind in industry, this unique design downlight is high on benefits. It brings together performance & economy. Light in weight, this IP40 downlight has high efficiency driver & long life LED while also delivering 100 Lm/watt.

CAT. REF.	CASE LOT	MRP (₹)
CDR-219-12-57-SL-NWH	20	1400
CDR-219-15-57-SL-NWH	20	1500
CDR-219-18-57-SL-NWH	20	1600



STYLO-R

Stylo-R offers industry standard round - in - round design in white PDC aluminium housing with high performance Led & driver. Also available in warm white and natural white

CAT. REF.	CASE LOT	MRP (₹)
LCDRC-09-CDL	12	1420
LCDRC-12-CDL	12	1770
LCDRC-15-CDL	12	1890
LCDRC-18-CDL	12	2000



STYLO-O

Stylo-O is made of PDC aluminium body with PC diffuser which provides round in square theme. Stylo-O bring forth innovative design, circle in square shape which It creates illusion of ceiling merging with luminaire, as the contrast of two primary shapes create a strong form. Efficacy: 100 lm/W. Also available in warm white and natural white

CAT. REF.	CASE LOT	MRP (₹)
LCDRO-09-CDL	12	1360
LCDRO-12-CDL	12	1660
LCDRO-15-CDL	12	1770
LCDRO-18-CDL	12	2310



QUARTZ+ S

Slim design LED recessed square polycarbonate housing down lighter with superior light output and integral driver. Efficacy 100lm/w. Also available in warm white and natural white

CAT. REF.	CASE LOT	MRP (₹)
LSDEP-06-CDL	40	620
LSDEP-09-CDL	40	650
LSDEP-12-CDL	20	1010
LSDEP-15-CDL	20	1070
LSDEP-18-CDL	20	1520



Note - Surface Ring for Quartz+ S: SFS-6/12/15/18 to be ordered Separately.

STYLO-Q

Stylo-Q is made of PDC aluminium body with PC diffuser which provides square in circle theme. Stylo-Q bring forth innovative design, circle in square shape which It creates illusion of ceiling merging with luminaire, as the contrast of two primary shapes create a strong form. Efficacy: 100 lm/W. Also available in warm white and natural white

CAT. REF.	CASE LOT	MRP (₹)
LCDRQ-09-CDL	12	1420
LCDRQ-12-CDL	12	1770
LCDRQ-15-CDL	12	1890
LCDRQ-18-CDL	12	2000



STYLO-S

Stylo-S comprises of Plastic moulded housing finished in white & frosted designer diffuser. The downlighter is pre-wired with high efficiency electronic driver. Its unique design helps to get glare a free, smooth light distribution.

CAT. REF.	CASE LOT	MRP (₹)
LCDRS-09-CDL	12	1360
LCDRS-12-CDL	12	1660
LCDRS-15-CDL	12	1770
LCDRS-18-CDL	12	2310



PROXIMA-R

Proxima-R is a high performance low-height back lit downlighter suited for any modern professional workspace. Robust PDC aluminium housing ensures long life. Available in 3000K, 4000K and 5700K CCT. Efficacy: 100 lm/W.

CAT. REF.	CASE LOT	MRP (₹)
CDR-204-06-57-SL-NWH	20	1420
CDR-205-12-57-SL-NWH	20	1890
CDR-205-15-57-SL-NWH	20	2130
CDR-206-18-57-SL-NWH	20	3070
CDR-216-30-57-SL-NWH	20	3780
CDR-216-40-57-SL-NWH	20	4720



PROXIMA-S

Proxima-S is a high performance low-height back lit downlighter suited for any modern professional workspace. Robust PDC aluminium housing ensures long life. Efficacy: 100 lm/W. Also available in warm white and natural white.

CAT. REF.	CASE LOT	MRP (₹)
CDR-207-06-57-SL-NWH	20	1420
CDR-208-12-57-SL-NWH	20	1890
CDR-208-15-57-SL-NWH	20	2130
CDR-209-18-57-SL-NWH	20	3070



PEARL ULTIMA

Round and Square recess mounted LED edge lit slim downlight with die-cast aluminium housing finished in premium white powder coating. Efficacy:100 lm/W & 120 lm/W. Also available in warm white and natural white

CAT. REF.	CASE LOT	MRP (₹)
LSCRM-6W-CDL	40	1010
LSCRM-12W-CDL	30	1300
LSCRM-15W-CDL	20	1660
LSCRM-18W-CDL	20	1890
LSCRM-24WCDL	20	2250
LSCSM-6W-CDL	40	1010
LSCSM-12W-CDL	30	1300
LSCSM-15W-CDL	20	1660
LSCSM-18W-CDL	20	1890
LSCSM-24W-CDL	20	2250



DECORATIVE SUSPENDED

PEARL NIOS

Round and Square surface mounted LED panel. PDC aluminium housing and high translucent frosted plastic diffuser makes it a robust Luminaire. Efficacy: 100 lm/W & 120 lm/W. Also available in warm white and natural white

CAT. REF.	CASE LOT	MRP (₹)
LCDSPLN-R-06-CDL	20	1180
LCDSPLN-R-12-CDL	20	1720
LCDSPLN-R-15-CDL	20	1890
LCDSPLN-R-18-CDL	20	2360
LCDSPLN-R-24-CDL	20	2700
LCDSPLN-S-06-CDL	20	1180
LCDSPLN-S-12-CDL	20	1720
LCDSPLN-S-15-CDL	20	1890
LCDSPLN-S-18-CDL	20	2360
LCDSPLN-S-24-CDL	20	2700



LUNAR

A timeless classic, the LUNAR is the top of its class when it comes to large disk feature lighting. With a range of 3 sizes, ideal for modern living spaces where design and interest are upper most. Also available in warm white and natural white

CAT. REF.	CASE LOT	MRP (₹)
LCSUR3-25-CDL	2	9210
LCSUR4-36-CDL	2	10390
LCSUR6-40-CDL	2	14160



EPSILON

The hexagonal Epsilon is meticulously welded to resemble uniform light that softens up the overall light source and exemplifies illumination on a grand scale.

CAT. REF.	CASE LOT	MRP (₹)
CCP-128-36-30-SL-NWH	1	11800
CCP-128-36-40-SL-NWH	1	11800
CCP-128-36-57-SL-NWH	1	11800



QUARTZ+ R

Slim design LED recessed round polycarbonate housing down lighter with superior light output and integral driver. Efficacy 100lm/w. Also available in warm white and natural white

CAT. REF.	CASE LOT	MRP (₹)
LCDEP-06-CDL	40	620
LCDEP-09-CDL	40	650
LCDEP-12-CDL	20	1010
LCDEP-15-CDL	20	1070
LCDEP-18-CDL	20	1520



CAPELLA

The triangular Capella is meticulously welded to resemble uniform light that softens up the overall light source and exemplifies illumination on a grand scale.

CAT. REF.	CASE LOT	MRP (₹)
CCP-129-36-30-SL-NWH	1	16520
CCP-129-36-40-SL-NWH	1	16520
CCP-129-36-57-SL-NWH	1	16520



Note - Surface Ring for Quartz+ R: SFR-6/12/15/18 to be ordered Separately.



BATTEN

BRIGHT LINEA

High-quality materials and design. Extruded aluminium housing enhances safety. High quality PC Diffuser. Reliable and robust housing structure, maximize the endurance over the life time slim Integrated design, easy to install Efficacy: 125 lm/W. Also available in warm white and natural white

CAT. REF.	CASE LOT	MRP (₹)
CCS-100-20-65-HL2-DP-NWH	20	1010
CCS-100-40-65-HL2-DP-NWH	20	-

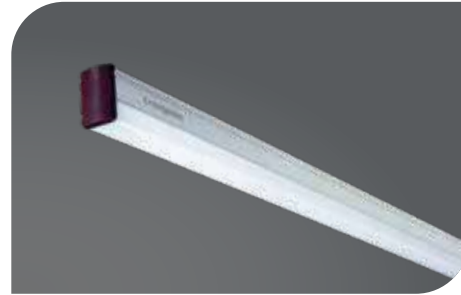

TRIMLINE NEU

Trimline Neu is a robust and high performance batten. This LED luminaire comprises of extruded channel in thermally conductive material. High translucent serrated milky white diffuser is used to get glare free and smooth light distribution. Efficacy: 100 lm/W. Also available in warm white and natural white

CAT. REF.	CASE LOT	MRP (₹)
CCS-103-05-65-SL-DP-NWH	20	490
CCS-103-10-65-SL-DP-NWH	20	650
CCS-103-20-65-SL-DP-NWH	20	950
CCS-100-40-65-SL-DP-NWH	20	1420
CCS-103-24-65-SL-DP-NWH	20	1200

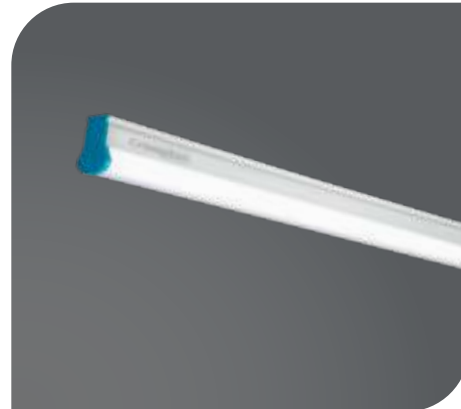

TRIM LINEA NEU

Trim Linea Neu is a PC batten. Compact appearance, simple and versatile in nature makes it as long lasting, efficient solution for offices and other commercial spaces. Efficacy: 100 lm/W. Also available in warm white and natural white

CAT. REF.	CASE LOT	MRP (₹)
TCS-104-20-65-SL-DP-NWH	20	740
TCS-104-10-65-SL-DP-NWH	20	610



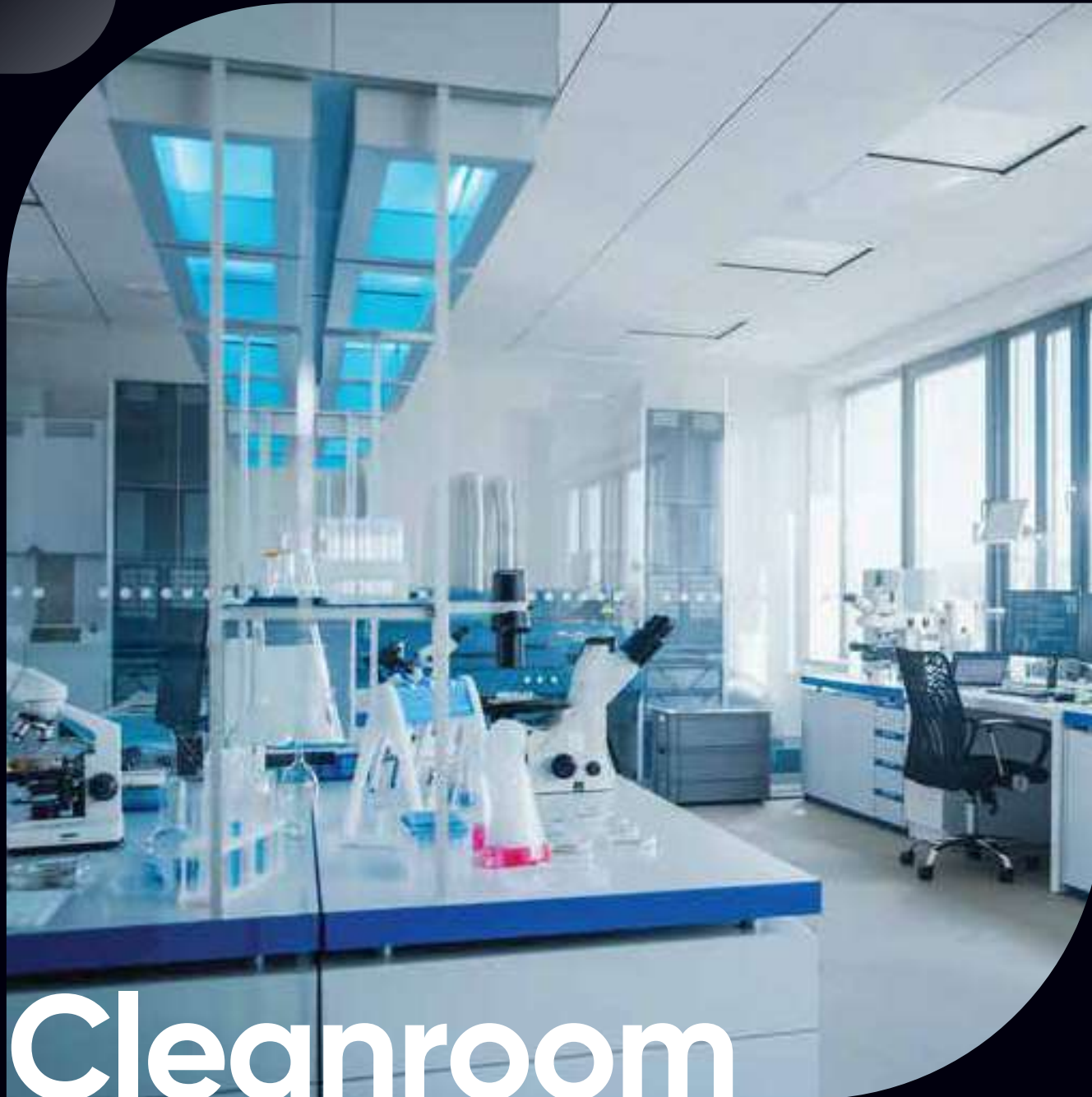

Cleanroom lighting

CLEANLUX I

Recessed mounted bottom opening LED Cleanroom luminaire (2X2). CRCA powder coated housing. SS Frame available on request. LCBOR-24-CDL is (1x1)

CAT. REF.	CASE LOT	MRP (₹)
LCBOR-24-CDL(1X1)	2	7700
LCBOR-40-CDL	1	12500
LCBOR-50-CDL	1	14200
LCBOR-60-CDL	1	14800

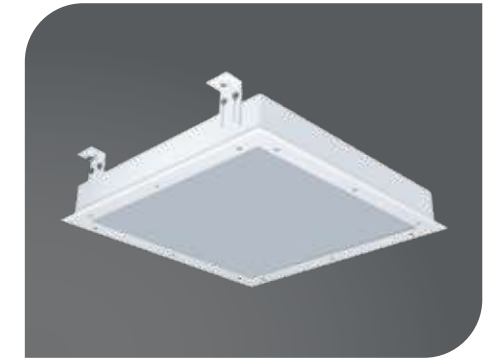

CLEANLUX II

Recessed mounted bottom opening LED Cleanroom luminaire (1X4). CRCA powder coated housing. SS Frame available on request.

CAT. REF.	CASE LOT	MRP (₹)
LCBOR-40-CDL(1X4)	1	14200
LCBOR-50-CDL(1X4)	1	16500
LCBOR-60-CDL(1X4)	1	22500



CLEANLUX III

Recessed mounted bottom opening LED Cleanroom luminaire (1X2). CRCA powder coated housing. SS Frame available on request.

CAT. REF.	CASE LOT	MRP (₹)
LCBOR-40-CDL(1X2)	1	11200



CLEANLUX IV

Recessed mounted top opening LED Cleanroom luminaire (2X2). CRCA powder coated housing. SS frame available on request.

CAT. REF.	CASE LOT	MRP (₹)
LCTOR-24-CDL(1X1)	2	11800
LCTOR-40-CDL	1	17700
LCTOR-50-CDL	1	19500
LCTOR-60-CDL	1	20000





LED HIGHBAYS

SURROUND ULTRA

Toughened glass round highbay in PDC housing suitable for industrial application. The luminaire has efficacy upto 125 lm/W. It has 10KV SPD & ingress protection of IP66 with additional safety chain.

CAT. REF.	CASE LOT	MRP (₹)
LHB11-80-CDL60HPM	2	18880
LHB11-100-CDL60HPM	2	21240
LHB11-120-CDL60HPM	2	23600
LHB11-140-CDL60HPM	2	25960
LHB11-150-CDL/60-HPM	2	18880



SURROUND NEO

Round highbay in PDC housing and toughened glass suitable for industrial application. The luminaire has efficacy of 110 lm/w, 10KV SPD & ingress protection of IP66 with additional safety chain.

CAT. REF.	CASE LOT	MRP (₹)
LHB11-80-CDL/60-M	2	14160
LHB11-100-CDL/60-M	2	15930
LHB11-120-CDL/60-M	2	17110
LHB11-140-CDL/60-M	2	20060
LHB11-150-CDL/60-M	2	21240



Industrial lighting

PARABOLA ULTRA PLUS

High efficiency round highbay in PDC housing & IP lens suitable for industrial application. The luminaire has efficacy >150 lm/W to reduce quantity/wattage thereby reducing operational cost. It has 10KV SPD & ingress protection of IP66 with additional safety chain

CAT. REF.	CASE LOT	MRP (₹)
CIP-327-100-57-60D-HL2-LM-NSG	2	17000
CIP-327-120-57-60D-HL2-LM-NSG	2	18500
CIP-327-150-57-60D-HL2-LM-NSG	2	21830
CIP-327-100-57-60D-HL5-LM-NSG	2	25960
CIP-327-120-57-60D-HL5-LM-NSG	2	28320



PARABOLA ULTRA

Uniquely designed circular highbay with IP lens for better lighting distribution. Available in lumens >120 lm/W, >130 lm/W making it a versatile solution for various industrial application. It has 4KV in-built surge protection & ingress protection of IP66 with additional safety chain.

CAT. REF.	CASE LOT	MRP (₹)
CIP-326-180-57-60D-HL2-LM-NSG	1	31860
CIP-326-200-57-60D-HL2-LM-NSG	1	33040
CIP-326-180-57-60D-HL3-LM-NSG	1	34220
CIP-326-200-57-60D-HL3-LM-NSG	1	35400



PARABOLA NEO

Uniquely designed circular highbay with 150 lm/W efficacy and 10 kV SPD as standard making it a robust solution for various industrial application. Ingress protection of IP66 with additional safety chain

CAT. REF.	CASE LOT	MRP (₹)
CIP-325-150-57-60D-HL5-LM-NSG	1	31860
CIP-325-180-57-60D-HL5-LM-NSG	1	34220
CIP-325-200-57-60D-HL5-LM-NSG	1	35400



SURROUND NEO (T)

Round highbay in PDC housing suitable for industrial application. The luminaire has efficacy of 110 lm/w. It has 4KV inbuilt SPD & ingress protection of IP66 with additional safety chain.

CAT. REF.	CASE LOT	MRP (₹)
TIP-320-80-57-SL-GL-NSG	2	14160
TIP-320-100-57-SL-GL-NSG	2	15930
TIP-320-120-57-SL-GL-NSG	2	17110
TIP-320-150-57-SL-GL-NSG	2	21240



LED WELLGLASS

CAVELO

Cavelo Trade is an integrated well glass luminaire with die cast canopy & gear housing. A versatile well glass series with both eye bolt & cradle for multiple mounting options. This IP66 well glass series delivers 120 lumens per watt.

CAT. REF.	CASE LOT	MRP (₹)
CIP-312-30-57-SL-CP-NBK	8	4250
CIP-312-35-57-SL-CP-NBK	8	4720
CIP-312-40-57-SL-CP-NBK	8	4960
TIP-312-30-57-SL-CP-NBK	8	3960
TIP-312-35-57-SL-CP-NBK	8	4020
TIP-312-40-57-SL-CP-NBK	8	4200



CAVELO

Cavelo is an integrated well glass luminaire with die cast canopy & gear housing. This IP66 well glass series delivers >120 lumens per watt

CAT. REF.	CASE LOT	MRP (₹)
TIP-314-70-57-SL-CP-NSG	8	9440
CIP-314-70-57-SL-CP-NSG	8	10620



PHOTON ULTRA PLUS

High efficacy wellglass which consumes lesser energy and maintains high lighting levels. Luminaire efficacy of 140 lm/W to reduce quantity/wattage thereby reducing operational cost. Ingress protection of IP66. Available in Clear PC.

CAT. REF.	CASE LOT	MRP (₹)
CIP-311-30-57-HL4-CP-NSG	8	6000
CIP-311-35-57-HL4-CP-NSG	8	6140
CIP-311-40-57-HL4-CP-NSG	8	6490



SUPRA NEO-II (T)

Eco Wellglass in PDC housing with a luminaire efficacy of 110 lm/W. Superior tapered fin design with exceptional thermal management. Ingress protection of IP66. 10KV SPD available in TIP-311-70-57-SL-CP-NSG

CAT. REF.	CASE LOT	MRP (₹)
TIP-311-35-57-SL-CP-NSG	2	4020
TIP-311-40-57-SL-CP-NSG	2	4200
TIP-311-70-57-SL-CP-NSG	2	9440



LED UNDER CANOPY

NEPTUNE NEO-II

PDC aluminium constructed recessed mounted under canopy luminaire with superior aesthetic finish and high reliability making it an ideal solution for petrol pumps. It has 10KV SPD & ingress protection of IP66. Available in 600x600 mm frame.

CAT. REF.	CASE LOT	MRP (₹)
LCNP-80-CDL/60-M	6	10510
LCNP-90-CDL/60-M	6	14160
LCNP-100-CDL/60-M	6	14160

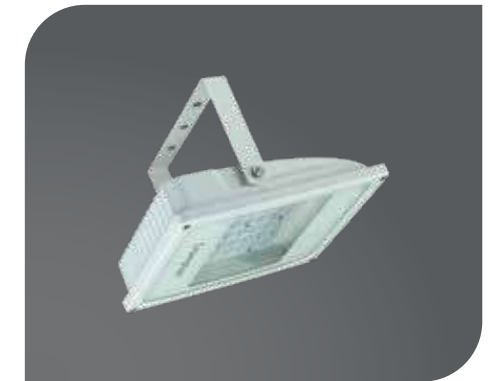

NEPTUNE ULTRA-II

High efficacy under canopy which consumes lesser energy and maintains high lighting levels. Luminaire efficacy of 125 lm/W to reduce quantity/wattage thereby reducing operational cost. It has 10KV SPD & ingress protection of IP66. Available in 600x600 frame.

CAT. REF.	CASE LOT	MRP (₹)
LCNP-80-CD60HPM	6	14160
LCNP-80-CD60HPM600	1	18880

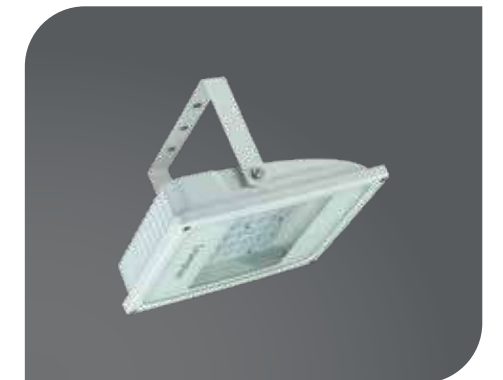

VISUALINE

Crompton's Linear under-canopy Visualine comes with a fresh linear design that completely changes the look of traditional petrol stations. With its superior design, Visualine delivers excellent illumination and creates a beautiful picture to behold. It has 10KV SPD (optional) & ingress protection of IP66.

CAT. REF.	CASE LOT	MRP (₹)
CIR-328-80-65-SL-DP-NWH	4	26000
CIR-328-80-57-SL-DP-NWH	-	-

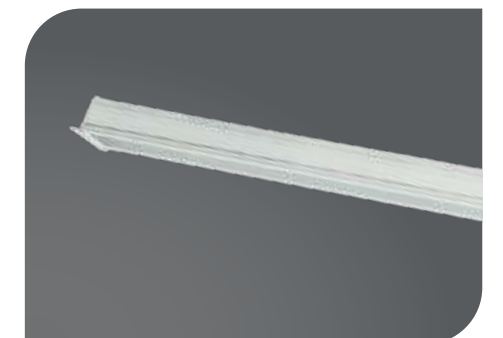



LED BULK HEAD & INDUSTRIAL BATTEN

BAZLEY

Pressure Die Cast Aluminium Bulkhead fixture is a weatherproof lighting solution commonly used in outdoor and industrial settings. The "IP66" rating indicates that it is highly resistant to dust and water, making it suitable for outdoor installations. This 10W LED Bulkhead is energy-efficient, provides smooth light distribution and long-lasting.

CAT. REF.	CASE LOT	MRP (₹)
CIS-306-10-57-SL-DP-NBK	12	2360
CIS-306-10-30-SL-DP-NBK	12	2360



TECHLITA MINI

PC PC Co extruded IP65 Compact modern Design utility bulkhead with high energy savings.

CAT. REF.	CASE LOT	MRP (₹)
TIS-304-10-57-SL-DP-NWH	10	1420
TIS-304-10-30-SL-DP-NWH	10	1420



TECHLITA

PC - PC Co-extruded IP65 batten, with superior product design and multi-functional applications, Crompton's Techlita is positioned to cater to the lighting requirements of multiple industries striving for maximum energy savings & robust product performance.

CAT. REF.	CASE LOT	MRP (₹)
CIS-301-20-57-HL3-DP-NWH	8	3800
CIS-301-40-57-HL3-DP-NWH	6	4000



SHIELD

Surface/Suspended waterproof industrial luminaire with polycarbonate housing and diffuser suitable for single and twin 4 Ft T8 tube. Ingress protection of IP66. LED Tube to be ordered separately

CAT. REF.	CASE LOT	MRP (₹)
IPFC121LT8	10	2360
IPFC122LT8	10	2720

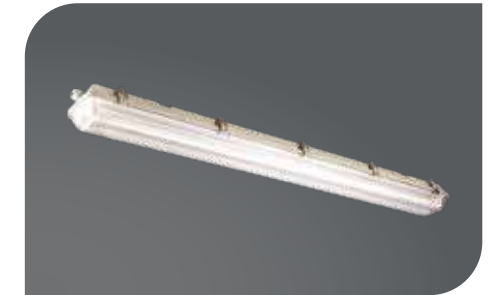

SHELTER

High Performance integrated LED Batten to create a sustainable lighting environment with surface / suspended mounting.

CAT. REF.	CASE LOT	MRP (₹)
CIS-305-40-57-SL-DP-NWH	6	3310



SHELTER ULTRA

High efficacy integrated LED Batten to create a sustainable lighting environment with surface /suspended mounting with efficacy of 120 lm/W.

CAT. REF.	CASE LOT	MRP (₹)
CIS-305-40-57-HL2-DP-NWH	6	4130

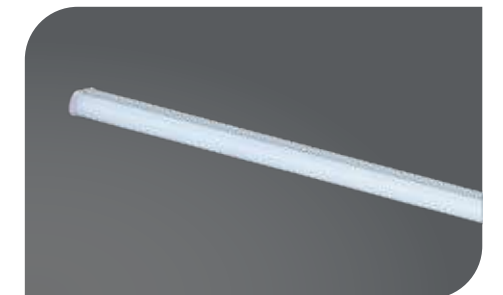

ECO

Compact industrial batten suitable for single T8 LED tube.

CAT. REF.	CASE LOT	MRP (₹)
DIJB12LT8-20	20	480

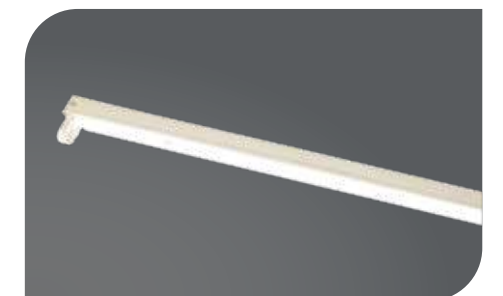

ECO-I

High efficacy integrated LED Batten to create a sustainable lighting environment with surface/suspended mounting.

CAT. REF.	CASE LOT	MRP (₹)
IGP161LT8-16 1 x T8	20	710
IGP162 LT8-16 2 x T8	20	770

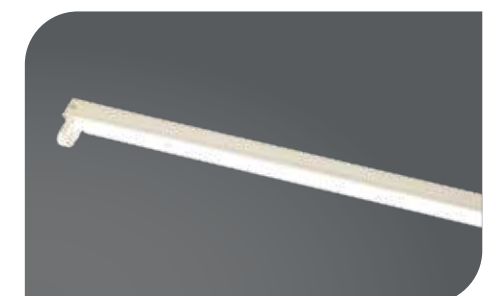

ATTITUBE

Surface mounted Compact Industrial Batten suitable for Single and double T8 LED Tube

CAT. REF.	CASE LOT	MRP (₹)
IS-340-NWH	20	485
IS-314-NWH	20	570

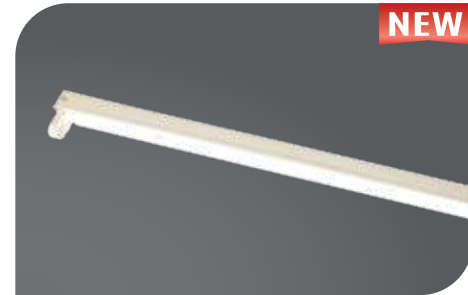

ASTO PRO

High performing versatile product for multiple applications, Asto Pro LED Tube is ideal for almost all indoor applications. It has efficacy of >100 lumens per Watt & has double sided connection for additional safety measure of avoiding short circuit.

CAT. REF.	CASE LOT	MRP (₹)
TCS-726-20-65-SL-DP-NWH	20	680



CRYSTA

LED Glass T8 tube (LGT8) with in built driver and efficacy of 100 lm/W. LED Aluminium T8 tube (LTT8) with in built driver and efficacy of 100 lm/W.

CAT. REF.	CASE LOT	MRP (₹)
LGT8-20-865-2	20	650
LTT8-20	20	1010

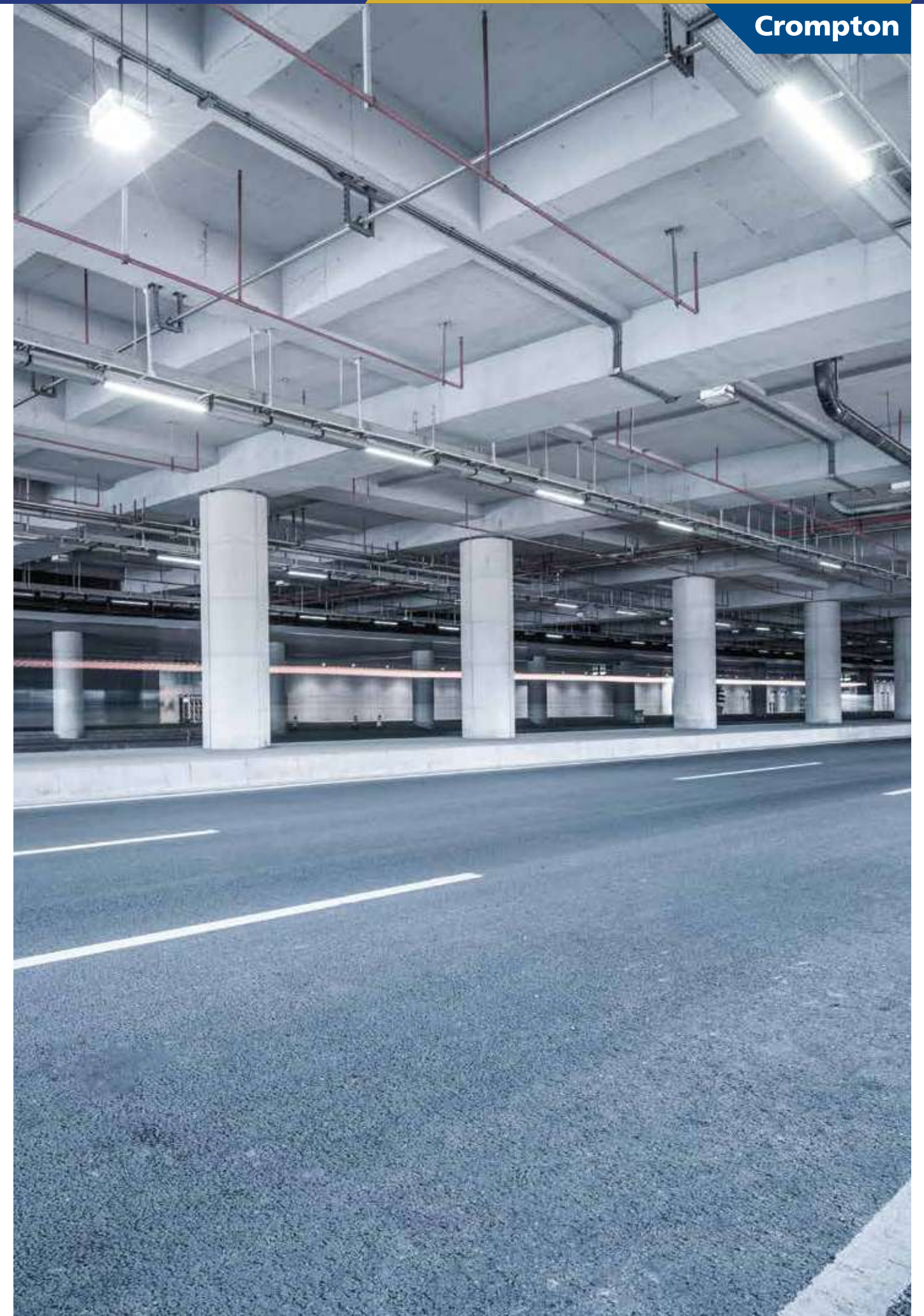
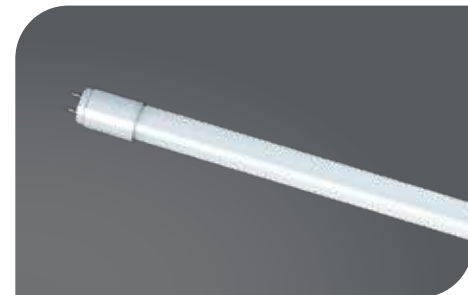



Flameproof lighting

FLOGA

Flameproof fixtures are designed to ensure that internal ignition within a flammable atmosphere will not transmit outside the protective enclosure. Crompton's flameproof luminaires are ideal for Industrial applications. CIMFR - BIS - PESO Certified. Recommended for Gas Group IIC, Zone 1 and 2. Temperature Class T6

CAT. REF.	CASE LOT	MRP (₹)
FFL1315-80-CDL/60-M	1	26000
FFL1315-100-CDL/60-M	1	31000
FFL1315-120-CDL/60-M	1	33000
FFL1315-150-CDL/60-M	1	38000
FFL1315-200-CDL/60-M	1	78000
FFL1315-250-CDL/60-M	1	85000
FFL1315-300-CDL/60-M	1	95000
FFL1315-80-CDL/60-HB-M	1	26000
FFL1315-100-CDL/60-HB-M	1	31000
FFL1315-120-CDL/60-HB-M	1	33000
FFL1315-150-CDL/60-HB-M	1	38000
FFL1315-200-CDL/60-HB-M	1	78000
FFL1315-250-CDL/60-HB-M	1	85000
FFL1315-300-CDL/60-HB-M	1	95000

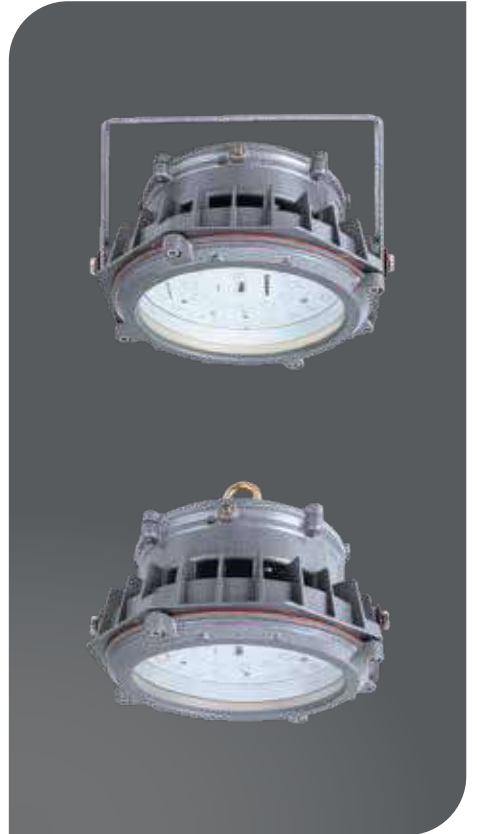

PETROLUX

Flameproof fixtures are designed to ensure that internal ignition within a flammable atmosphere will not transmit outside the protective enclosure. Crompton's flameproof luminaires are ideal for Industrial applications. CIMFR - BIS - PESO Certified. Recommended for Gas Group IIC, Zone 1 and 2. Temperature Class T6

CAT. REF.	CASE LOT	MRP (₹)
FWL1318-30-CDL-M	2	15000
FWL1318-40-CDL-M	2	17500
FWL1318-60-CDL-M	2	19000
FWL1318-45-CDL-M	2	18200



FIAMMA II

CIMFR certified LED flameproof batten suitable for single and twin T8 tube of 16W/20W. Recommended for Gas/Vapor group of IIA & IIB and Zone 1 & 2. IP65 Protected. LED tubes to be ordered separately. CIMFR - BIS - PESO Certified.

CAT. REF.	CASE LOT	MRP (₹)
EXTN1LT8-16/20-VE	1	15000
EXTN2LT8-16/20-VE	1	16000

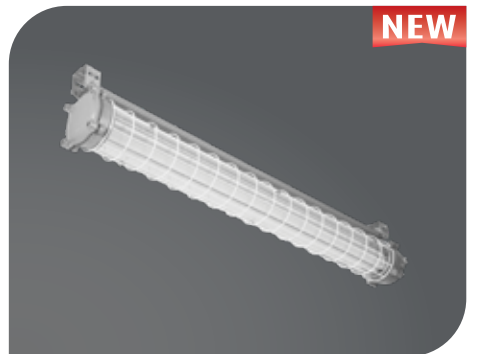



Street lighting

WANDERER

WANDERER is a Perfect for lighting up gated communities, gardens and municipal roads. It uses a unique air vent technology which keeps temperatures low, needless to say this allows the LEDs to shine even brighter. The light also has an inbuilt surge protection. IP66 Efficacy \geq 110LPW

CAT. REF.	CASE LOT	MRP (₹)
TRP-415-20-57-SL-LM-NBK	12	2600
TRP-415-25-57-SL-LM-NBK	12	2800
TRP-415-30-57-SL-LM-NBK	12	3200
TRP-415-25-30-SL-LM-NBK	12	On Request
TRP-415-30-30-SL-LM-NBK	12	On Request



WANDERER PRO

WANDERER PRO is perfect for lighting up gated communities, gardens and municipal roads. It uses a unique air vent technology which keeps temperatures low, needless to say this allows the LEDs to shine even brighter. The light also has an inbuilt surge protection (Optional 10KV SPD) IP66 Efficacy \geq 110LPW

CAT. REF.	CASE LOT	MRP (₹)
CRP-420-25-57-SL-LM-NSG	12	On Request
CRP-420-30-57-SL-LM-NSG	12	On Request
CRP-420-25-30-SL-LM-NSG	12	On Request
CRP-420-30-30-SL-LM-NSG	12	On Request

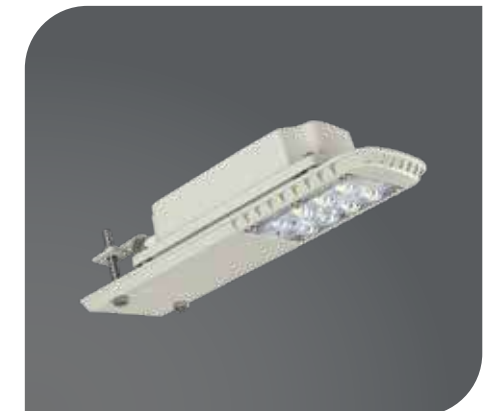

TURBO

TURBO street lights are made up of pressure die cast housing with integrated lenses and high power LED's with IP66 protection. Efficacy \geq 100LPW

CAT. REF.	CASE LOT	MRP (₹)
TRP-400-20-57-SL-LM-NSR	12	2800
TRP-400-25-57-SL-LM-NSR	12	3000
TRP-400-30-57-SL-LM-NSR	12	3400
TRP-400-35-57-SL-LM-NSR	12	4000



ASTRA NEO

ASTRA NEO street lights are made up of pressure die cast housing with toughened glass and high power LED's with secondary optics and IP66 protection. Efficacy ≥ 110LPW

CAT. REF.	CASE LOT	MRP (₹)
LSTS-20-CDL-M	12	3000
LSTS-20-CDL/NL-M	12	2900
LSTS-25-CDL-M	12	3200
LSTS-25-CDL/NL-M	12	3100
LSTS-30-CDL-M	12	3500
LSTS-30-CDL/NL-M	12	3400

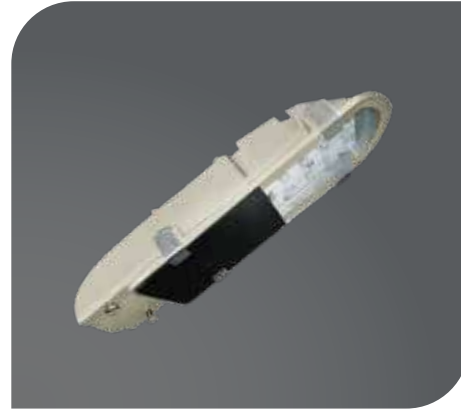

WANDERER PLUS

WANDERER PLUS is a Perfect for lighting up gated communities, gardens and municipal roads. It uses a unique air vent technology which keeps temperatures low, needless to say this allows the LEDs to shine even brighter. The light also has an inbuilt surge protection. IP66 Efficacy ≥ 110 LPW

CAT. REF.	CASE LOT	MRP (₹)
TRP-417-45-57-SL-LM-NBK	12	5800
TRP-417-45-30-SL-LM-NBK	12	On Request

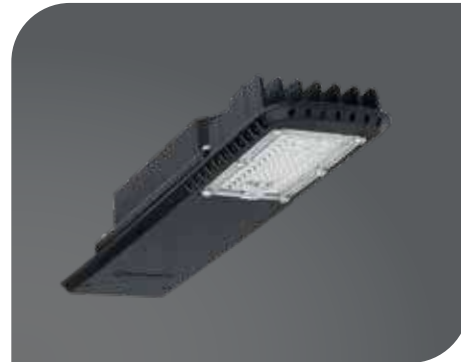

WANDERER PRO

WANDERER PRO is perfect for lighting up gated communities, gardens and municipal roads. It uses a unique air vent technology which keeps temperatures low, needless to say this allows the LEDs to shine even brighter. The light also has an inbuilt surge protection (Optional 10KV SPD) IP66 Efficacy ≥ 110LPW

CAT. REF.	CASE LOT	MRP (₹)
CRP-417-45-57-SL-LM-NSG	12	6200
CRP-417-45-30-SL-LM-NSG	12	On Request
CRP-417-45-30-SL-NS-LM-NSG	12	On Request



FREEDOM NEO

FREEDOM NEO street lights are made up of pressure die cast housing with toughened glass and high power LED's with secondary optics and IP66 protection. (Optional 10KV SPD) Efficacy ≥ 110LPW

CAT. REF.	CASE LOT	MRP (₹)
CRP-423-45-57-SL-GL-NSG	6	6200
CRP-423-45-30-SL-GL-NSG	6	6400

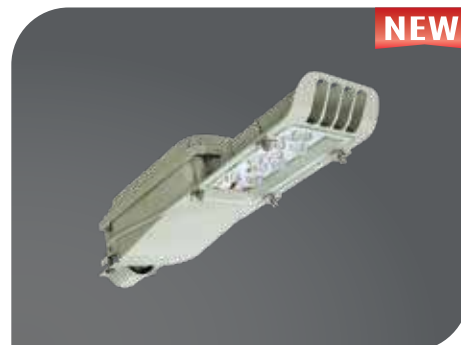

WANDERER PLUS

WANDERER PLUS is a Perfect for lighting up gated communities, gardens and municipal roads. It uses a unique air vent technology which keeps temperatures low, needless to say this allows the LEDs to shine even brighter. The light also has an inbuilt surge protection. IP 66 and Efficacy ≥ 120 LPW, 10KV SPD

CAT. REF.	CASE LOT	MRP (₹)
TRP-421-60-57-SL-LM-NBK	6	6200
TRP-421-60-30-SL-LM-NBK	6	On Request
TRP-421-70-57-SL-LM-NBK	6	6800
TRP-421-70-30-SL-LM-NBK	6	On Request



WANDERER PRO

WANDERER PRO is a Perfect for lighting up gated communities, gardens and municipal roads. It uses a unique air vent technology which keeps temperatures low, needless to say this allows the LEDs to shine even brighter. The light also has an inbuilt surge protection. IP 66 and Efficacy ≥ 120 LPW, 10KV SPD

CAT. REF.	CASE LOT	MRP (₹)
CRP-421-60-57-SL-LM-NSG	6	On Request
CRP-421-70-57-SL-LM-NSG	6	On Request



WANDERER PLUS

WANDERER PLUS is a Perfect for lighting up gated communities, municipal roads. It uses a unique air vent technology which keeps temperatures low, needless to say this allows the LEDs to shine even brighter. The light also has an inbuilt surge protection. IP 66 and Efficacy ≥ 120 LPW, 10KV SPD

CAT. REF.	CASE LOT	MRP (₹)
TRP-425-90-57-HL2-LM-NBK	4	9050
TRP-426-120-57-HL2-LM-NBK	4	1250
TRP-425-90-30-HL2-LM-NBK	4	On Request
TRP-426-120-30-HL2-LM-NBK	4	On Request



WANDERER PRO

WANDERER PRO is a Perfect for lighting up gated communities, municipal roads. It uses a unique air vent technology which keeps temperatures low, needless to say this allows the LEDs to shine even brighter. The light also has an inbuilt surge protection. IP 66 and Efficacy ≥ 120 LPW, 10KV SPD

CAT. REF.	CASE LOT	MRP (₹)
CRP-425-90-57-HL2-LM-NSG	4	On Request
CRP-426-120-57-HL2-LM-NSG	4	On Request



VEGA

VEGA LED street light is an ideal product for gated communities and municipal roads. It uses a unique heat design to keep the product air cooled, an efficient integrated IP lens ensures proper light distribution with IP66 protection. The light also has an inbuilt surge protection with 10KV SPD included, Efficacy ≥ 110 LPW

CAT. REF.	CASE LOT	MRP (₹)
TRP-412-90-57-SL-GL-NSG	4	9200
TRP-412-90-30-SL-GL-NSG	4	9800
CRP-412-90-57-SL-GL-NSG	4	9800

RAPTOR NEO

RAPTOR NEO street lights are aerodynamically designed for all weather conditions with excellent thermal management, made with pressure die cast housing with toughened glass and high power LED's with secondary optics and IP66 protection. Efficacy $> 110/120$ LPW, available with 10KV SPD

CAT. REF.	CASE LOT	MRP (₹)
TRP-409-45-57-SL-GL-NSG	6	6200
TRP-409-60-57-SL-GL-NSG	6	6900
TRP-409-70-57-SL-GL-NSG	6	7600
TRP-411-90-57-SL-GL-NSG	4	9800
TRP-411-100-57-SL-GL-NSG	4	10800
TRP-411-120-57-SL-GL-NSG	4	13500
TRP-409-60-30-SL-GL-NSG	6	7200
TRP-409-70-30-SL-GL-NSG	6	7900
TRP-411-90-30-SL-GL-NSG	4	10200
TRP-411-120-30-SL-GL-NSG	4	14000
TRP-409-45-57-HL2-GL-NSG	6	6600
TRP-409-60-57-HL2-GL-NSG	6	7800
TRP-409-70-57-HL2-GL-NSG	6	8600
TRP-411-90-57-HL2-GL-NSG	4	10500
TRP-411-100-57-HL2-GL-NSG	4	11500
TRP-411-120-57-HL2-GL-NSG	4	14000

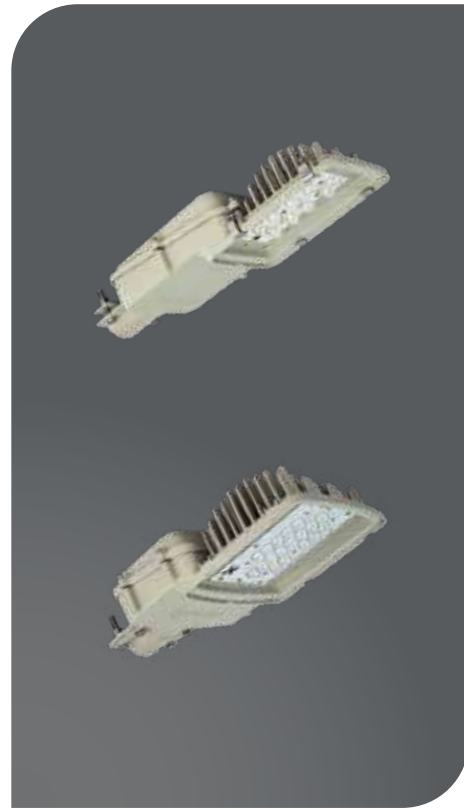
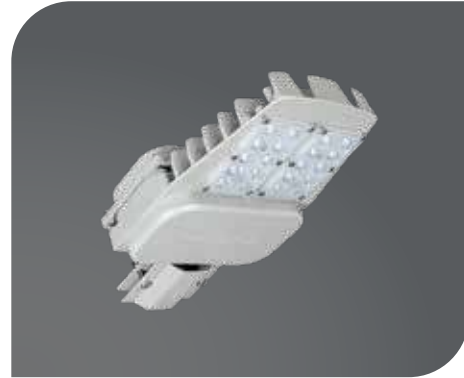

RAPTOR PRO

Street lights are aerodynamically designed for all weather conditions with excellent thermal management, made up of pressure die cast housing with toughened glass and high power LED's with secondary optics and IP66 protection. 10 KV SPD included, Efficacy $\geq 110/120$ LPW

CAT. REF.	CASE LOT	MRP (₹)
CRP-409-45-57-SL-GL-NSG	6	6600
CRP-409-60-57-SL-GL-NSG	6	7800
CRP-409-70-57-SL-GL-NSG	6	8000
CRP-411-90-57-SL-GL-NSG	4	10500
CRP-411-100-57-SL-GL-NSG	4	12000
CRP-411-120-57-SL-GL-NSG	4	14000
CRP-409-60-30-SL-GL-NSG	6	7400
CRP-409-70-30-SL-GL-NSG	6	8200
CRP-411-90-30-SL-GL-NSG	4	10400
CRP-411-120-30-SL-GL-NSG	4	14500
CRP-409-45-57-HL2-GL-NSG	6	6800
CRP-409-60-57-HL2-GL-NSG	6	8000
CRP-409-70-57-HL2-GL-NSG	6	8800
CRP-411-90-57-HL2-GL-NSG	4	11000
CRP-411-100-57-HL2-GL-NSG	4	12500
CRP-411-120-57-HL2-GL-NSG	4	15000



NEXUS STAR NEO

Street lights are aerodynamically designed for all weather conditions with excellent thermal management, made up of pressure die cast housing with toughened glass/ Integrated lens and high power LED's with secondary optics and IP66 protection. 10 KV SPD included, Efficacy $\geq 110/120$ LPW

CAT. REF.	CASE LOT	MRP (₹)
TRP-424-150-57-HL2-LM-NSG	2	17500
TRP-424-150-57-SL-GL-NSG	2	16500
CRP-424-150-57-HL2-LM-NSG	2	18500
CRP-424-150-57-SL-GL-NSG	2	17500



FALCON PRO I

FALCON PRO I street lights are aerodynamically designed with built-in tilting arrangement and excellent thermal management, made from pressure die cast housing with toughened glass, high power LED's with secondary optics, IP66 protection. 10KV SPD Included, Efficacy $\geq 110/125/135$ LPW

CAT. REF.	CASE LOT	MRP (₹)
CRP-411-150-57-SL-GL-NSG	1	18500
CRP-411-150-57-HL2-GL-HR-NGG	1	23500
CRP-411-150-57-HL3-GL-HR-NGG	1	24500
CRP-413-180-57-HL2-GL-HR-NGG	1	29500
CRP-413-180-57-HL3-GL-HR-NGG	1	32000



FALCON PRO II

FALCON PRO II street lights are aerodynamically designed with built-in tilting arrangement and excellent thermal management, made from pressure die cast housing with toughened glass, high power LED's with secondary optics, IP66 protection. 10KV SPD Included, Efficacy ≥ 125/135LPW

CAT. REF.	CASE LOT	MRP (₹)
CRP-410-200-57--HL2-GL-HR-NGG	1	32000
CRP-410-200-57-HL3-GL-HR-NGG	1	34000
CRP-410-220-57-HL2-GL-HR-NGG	1	34000
CRP-410-220-57-HL3-GL-HR-NGG	1	36000
CRP-410-250-57-HL2-GL-HR-NGG	1	39000
CRP-410-250-57-HL3-GL-HR-NGG	1	42000

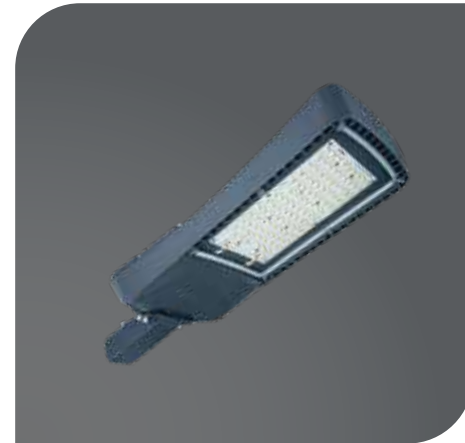

NEXUS PRO

NEXUS PRO LED streetlight made up of pressure die cast aluminium housing with toughened glass and high power LEDs and secondary lenses with IP66 protection. 10KV SPD included. Efficacy ≥ 110/120LPW

CAT. REF.	CASE LOT	MRP (₹)
CRP-414-180-57-SL-GL-NSG	1	22000
CRP-414-180-57-HL2-GL-NSG	1	23000
CRP-414-200-57-SL-GL-NSG	1	25000
CRP-414-200-57-HL2-GL-NSG	1	26000
CRP-414-220-57-SL-GL-NSG	1	27000
CRP-414-220-57-HL2-GL-NSG	1	28000



APLOMADA PRO

APLOMADO PRO is a high wattage street light meant for Highway & city roads, aerodynamically designed with excellent thermal management and superior secondary optics for better cost of ownership. IP66 protection, 10KV SPD, Efficacy > 125/135/140

CAT. REF.	CASE LOT	MRP (₹)
CRP-418-180-57-HL2-GL-HR-NSR	1	28500
CRP-418-180-57-HL3-GL-HR-NSR	1	30000
CRP-418-200-57-HL2-GL-HR-NSR	1	31000
CRP-418-200-57-HL3-GL-HR-NSR	1	32500
CRP-416-220-57-HL2-GL-HR-NSR	1	33000
CRP-416-220-57-HL3-GL-HR-NSR	1	34500
CRP-416-250-57-HL2-GL-HR-NSR	1	37500
CRP-416-250-57-SL-GL-NSG	1	32500
CRP-416-250-57-HL2-GL-NSG	1	34500
CRP-416-250-57-HL3-GL-HR-NSR	1	41000
CRP-416-250-57-HL4-GL-HR-NSR	1	44000
CRP-416-270-57-HL4-GL-HR-NSR	1	46000
CRP-416-250-57-HL5-LM-NSR	1	On Request
CRP-416-300-57-HL5-LM-NSR	1	On Request

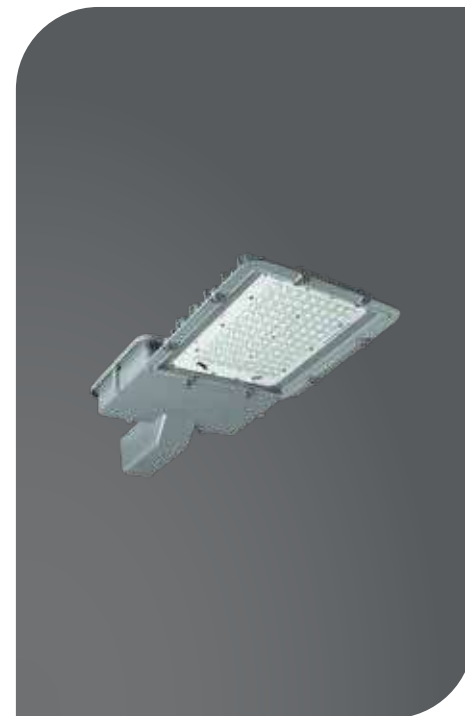



Flood lighting

ROVER

LED floodlight made up of pressure die cast aluminium housing with toughened glass and high power LEDs and secondary lenses with IP66 protection. System efficacy >110/120 LPW, 10KV SPD version to be ordered separately.

CAT. REF.	CASE LOT	MRP (₹)
TFS-504-50-57-NL-SL-GL-NBK	6	5600
CFS-504-50-57-60D-SL-GL-NSG	6	5800
CFS-504-50-30-60D-SL-GL-NSG	6	6200
TFS-504-60-57-60D-SL-GL-NSG	6	8400
TFS-504-60-30-60D-SL-GL-NSG	6	8600
TFS-504-60-57-60D-HL2-GL-NSG	6	9400



ROVER PLUS

LED floodlight made up of pressure die cast aluminium housing with toughened glass and high power LEDs and secondary lenses with IP66 protection. System efficacy >110/120 LPW, 10KV SPD to be ordered separately.

CAT. REF.	CASE LOT	MRP (₹)
TFS-504-70-57-60D-SL-GL-NSG	6	8800
TFS-504-70-30-60D-SL-GL-NSG	6	9000
TFS-504-70-57-60D-HL2-GL-NSG	6	11500
TFS-504-80-57-60D-SL-GL-NSG	6	10000
TFS-504-80-30-60D-SL-GL-NSG	6	10500
TFS-504-80-57-60D-HL2-GL-NSG	6	12000
TFS-504-100-57-60D-SL-GL-NSG	6	10500
TFS-504-100-57-NL-SL-GL-NBK	6	10250
TFS-504-120-57-60D-HL2-GL-NBK	6	14500
TFS-504-150-57-60D-HL2-GL-NBK	6	15500
CFS-504-100-30-60D-SL-GL-NSG	6	10800
TFS-504-100-57-60D-HL2-GL-NSG	6	12500
CFS-504-100-57-60D-HL2-GL-NSG	6	13500
CFS-504-120-57-60D-SL-GL-NSG	6	15000
CFS-504-120-57-60D-HL2-GL-NSG	6	16000



PROFILE NEO

LED floodlight made up of pressure die cast aluminium housing with toughened glass and high power LEDs and secondary lenses with IP66 protection. System efficacy 110/120LPW, 10KV SPD included.

CAT. REF.	CASE LOT	MRP (₹)
LFL-70-CDL/60-M	6	10500
LFL-70-WW/60-M	6	11500
LFL-70-CDL/60-HPM	6	12000
LFL-80-CDL/60-M	6	11000
LFL-80-WW/60-M	6	12000
LFL-80-CDL/60-HPM	6	13000



SPECTACLE

LED floodlight made up of pressure die cast aluminium housing with integrated IP lens and SMD LEDs with IP66 protection. System efficacy >120LPW, 10KV SPD included

CAT. REF.	CASE LOT	MRP (₹)
TFS-510-150-57-60D-HL2-LM-NGG	2	15300
TFS-510-150-30-60D-HL2-LM-NGG	2	On-request
TFS-511-200-57-60D-HL2-LM-NGG	2	19500
TFS-511-200-30-60D-HL2-LM-NGG	2	On-request



SPECTACLE PRO

LED floodlight made up of pressure die cast aluminium housing with integrated IP lens and SMD LEDs with IP66 protection. System efficacy >120LPW, 10KV SPD included

CAT. REF.	CASE LOT	MRP (₹)
CFS-510-150-57-60D-HL2-LM-NSG	2	17000
CFS-511-200-57-60D-HL2-LM-NSG	2	22000



PLUTO NEO AURA

LED floodlight made up of pressure die cast aluminium housing with toughened glass and high power LEDs and secondary lenses with IP66 protection. System efficacy ≥ 110/LPW 10KV SPD included.

CAT. REF.	CASE LOT	MRP (₹)
TFS-507-150-57-60D-SL-GL-NSG	2	16000
TFS-507-150-57-NL-SL-GL-NSG	2	15500
TFS-507-200-57-60D-SL-GL-NSG	2	22000
TFS-507-200-57-NL-SL-GL-NSG	2	21 000



PLUTO NEO

LED floodlight made up of pressure die cast aluminium housing with toughened glass and high power LEDs and secondary lenses with IP66 protection. System efficacy ≥ 110/120LPW 10KV SPD included.

CAT. REF.	CASE LOT	MRP (₹)
LFLN-135-CDL/60-M	2	16500
LFLN-135-WW/60-M	2	17000
LFLN-150-CDL/60-M	2	17500
LFLN-150-WW/60-M	2	18500
LFLN-150-CDL/60-HPM	2	18500
LFLN-180-CDL/60-M	2	18500
LFLN-180-WW/60-M	2	19500
LFLN-200-CDL/60-M	2	24000
LFLN-200-WW/60-M	2	25000
LFLN-200-CDL/60-HPM	2	25500



PLUTO PRO PLUS

LED floodlight made up of pressure die cast aluminium housing with toughened glass and high power LEDs and secondary lenses with IP66 protection. Available in MB/WB angles. 10KV SPD included, System Efficacy ≥ 110/120/135

CAT. REF.	CASE LOT	MRP (₹)
CFS-501-300-57-30D-HL2-GL-NGG	1	36500
CFS-501-300-57-30D-HL3-GL-NBK	1	48500
CFS-501-300-57-30D-SL-GL-NGG	1	33500
CFS-501-300-30-30D-SL-GL-NGG	1	34500
CFS-501-300-57-60D-HL2-GL-NGG	1	36000
CFS-501-300-57-60D-HL3-GL-NBK	1	48000
CFS-501-300-57-60D-SL-GL-NGG	1	33000
CFS-501-300-30-60D-SL-GL-NGG	1	34000
CFS-501-350-57-30D-HL2-GL-NGG	1	43000
CFS-501-350-57-30D-HL3-GL-NBK	1	55000
CFS-501-350-57-30D-SL-GL-NGG	1	40500
CFS-501-350-30-30D-SL-GL-NGG	1	42500
CFS-501-350-57-60D-HL2-GL-NGG	1	42500
CFS-501-350-57-60D-HL3-GL-NBK	1	54500
CFS-501-350-57-60D-SL-GL-NGG	1	40000
CFS-501-350-30-60D-SL-GL-NGG	1	42000



CHALLENGER PRO

Unique modular LED floodlight made up of pressure die cast aluminium housing with toughened glass and high power LEDs and secondary lenses with IP66 protection. Available in NB/MB/WB angles. 10KV SPD included, System Efficacy \geq 110/120/135 LPW.

CAT. REF.	CASE LOT	MRP (₹)
CFS-506-250-57-60D-SL-GL-NSG	1	30000
CFS-506-250-57-60D-HL2-GL-NSG	1	32500
CFS-506-250-57-30D-HL2-GL-NSG	1	33000
CFS-506-250-57-60D-HL3-GL-NBR	1	40500
CFS-506-250-57-30D-HL3-GL-NBR	1	41000
CFS-506-250-57-10D-HL2-GL-NBR	1	44000
CFS-506-250-57-10D-HL3-GL-NBR	1	46000
CFS-506-300-57-60D-SL-GL-NSG	1	33000
CFS-506-300-57-30D-SL-GL-NSG	1	On-request
CFS-506-300-57-60D-HL2-GL-NSG	1	On-request
CFS-506-300-57-30D-HL2-GL-NSG	1	On-request



CHALLENGER PRO

LED floodlight made up of pressure die cast aluminium housing with toughened glass and high power LEDs and secondary lenses with IP66 protection. Available in MB/WB angles. 10KV SPD included, System Efficacy \geq 110/120/135

CAT. REF.	CASE LOT	MRP (₹)
CFS-512-350-57-60D-SL-GL-NSG	1	40000
CFS-512-350-57-30D-SL-GL-NSG	1	40500
CFS-512-350-30-60D-SL-GL-NSG	1	42000
CFS-512-350-30-30D-SL-GL-NSG	1	42500
CFS-512-350-57-60D-HL2-GL-NSG	1	42500
CFS-512-350-57-30D-HL2-GL-NSG	1	43000
CFS-512-350-57-60D-HL3-GL-NGG	1	55000
CFS-512-350-57-30D-HL3-GL-NGG	1	56000
CFS-512-400-57-60D-SL-GL-NSG	1	45000
CFS-512-400-57-30D-SL-GL-NSG	1	45500
CFS-512-400-30-60D-SL-GL-NSG	1	49500
CFS-512-400-30-30D-SL-GL-NSG	1	50000
CFS-512-400-57-60D-HL2-GL-NSG	1	49500
CFS-512-400-57-30D-HL2-GL-NSG	1	50000
CFS-512-400-57-60D-HL3-GL-NGG	1	62000
CFS-512-400-57-30D-HL3-GL-NGG	1	62000



PLUTO PRO PLUS

LED floodlight made up of pressure die cast aluminium housing with toughened glass and high power LEDs and secondary lenses with IP66 protection. Available in MB/WB angles. 10KV SPD included, System Efficacy \geq 110/120/135

CAT. REF.	CASE LOT	MRP (₹)
CFS-513-500-57-60D-SL-GL-NSG	1	60000
CFS-513-500-57-30D-SL-GL-NSG	1	60500
CFS-513-500-57-60D-HL2-GL-NSG	1	65000
CFS-513-500-57-30D-HL2-GL-NSG	1	65500
CFS-513-500-30-60D-SL-GL-NSG	1	66000
CFS-513-500-30-30D-SL-GL-NSG	1	66550
CFS-513-500-57-60D-HL3-GL-NGG	1	72000
CFS-513-500-57-30D-HL3-GL-NGG	1	72500
CFS-513-500-57-10D-HL3-GL-NGG	1	79500



CHALLENGER PRO PLUS

Unique modular LED floodlight made up of pressure die cast aluminium housing with toughened glass and high power LEDs and secondary lenses with IP66 protection. Available in NB/MB/WB angles. 10KV SPD included, System Efficacy \geq 110/120/135 LPW

CAT. REF.	CASE LOT	MRP (₹)
CFS-506-500-57-60D-SL-GL-NSG	1	60000
CFS-506-500-57-10D-HL2-GL-NBR	1	77500
CFS-506-500-57-60D-HL2-GL-NSG	1	65000
CFS-506-500-57-30D-HL2-GL-NSG	1	65500
CFS-506-500-57-10D-HL3-GL-NBR	1	79500
CFS-506-500-57-30D-HL3-GL-NBR	1	72500
CFS-506-500-57-60D-HL3-GL-NBR	1	72000



MAGPIE NEO

Unique modular LED floodlight made up of pressure die cast aluminium housing with toughened glass and high power LEDs and secondary lenses with IP66 protection. 10KV SPD included, System Efficacy \geq 125/140 LPW.

CAT. REF.	CASE LOT	MRP (₹)
CFS-502-960-57-10D-HL2-GL-NSR	1	165000
CFS-502-960-57-10D-HL4-GL-NSR	1	175000
CFS-502-960-57-30D-HL2-GL-NSR	1	155000
CFS-502-960-57-30D-HL4-GL-NSR	1	164000
CFS-502-960-57-60D-HL2-GL-NSR	1	154000
CFS-502-960-57-60D-HL4-GL-NSR	1	165000



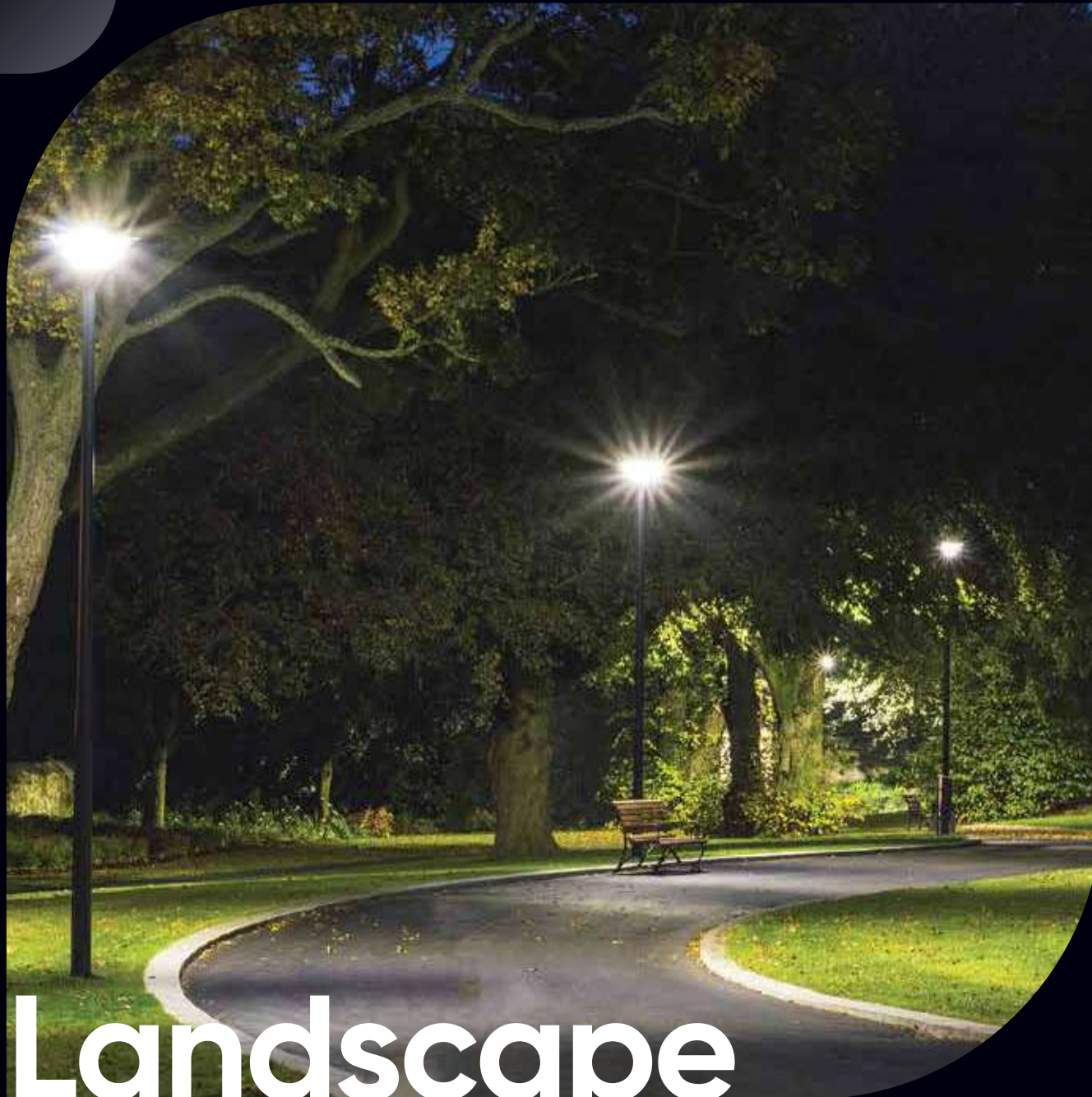

Landscape lighting

CHAPLET

Decorative Post top for indirect light with IP65 protection. Resistant to impact and corrosion. Glare-free and better uniformity. Also available in warm white

CAT. REF.	CASE LOT	MRP (₹)
CBP-610-25-57-SL-CA-NBK	1	10000
CBP-610-35-57-SL-CA-NBK	1	10500
CBP-610-40-57-SL-CA-NBK	1	11000
CBP-610-60-57-SL-CA-NBK	1	15500



MAPLE

Decorative Post top for 360° indirect light with IP 65 protection. Resistant to impact and corrosion. Glare-free and better uniformity

CAT. REF.	CASE LOT	MRP (₹)
LPTO-40-CDL-M	1	14500
LPTO-40-WW-M	1	15500
LPTO-60-WW-M	1	19500
LPTO-60-CDL-M	1	18500



NEBULA

IP65 Rated LED Post Top with moonlight effect and efficient light distribution. Also available with integrated decorative pole on request

CAT. REF.	CASE LOT	MRP (₹)
LPTM-40-CDL	1	12000
LPTM-40-WW	1	13000



HERITAGE

IP65 Rated LED Post Top ideal to light up parks, gardens and heritage sites

CAT. REF.	CASE LOT	MRP (₹)
LPTH-20-CDL	1	8500
LPTH-20-WW	1	8800



TERRIAN

TERRAIN Post Top lantern is a weather proof indirect lighting solution which improves horizontal uniformity, with reduced glare and improved lighting control IP65

CAT. REF.	CASE LOT	MRP (₹)
LPTC-40-CDL	1	12000
LPTC-40-WW	1	12500



TWISTER

IP65 Rated LED Bollard with robust design and efficient light distribution

CAT. REF.	CASE LOT	MRP (₹)
LBLTW-10-CDL	4	6000
LBLTW-10-WW	4	6250



SYRUS

IP65 Rated LED Bollard with robust design and efficient light distribution

CAT. REF.	CASE LOT	MRP (₹)
LBLSR-10-CDL	4	5500
LBLSR-10-WW	4	5800



LIARA

IP65 rated Inverted Pyramid Tripod type LED Bollard with soft 360° light distribution

CAT. REF.	CASE LOT	MRP (₹)
LBLSN-10-CDL	4	10000
LBLSN-10-WW	4	10500



MAYA I

Pressure die cast powder coated housing with PC diffuser. Efficient high output LED with IP65 protection

CAT. REF.	CASE LOT	MRP (₹)
LBLA1-10-CDL	4	4500
LBLA1-10-WW	4	4800

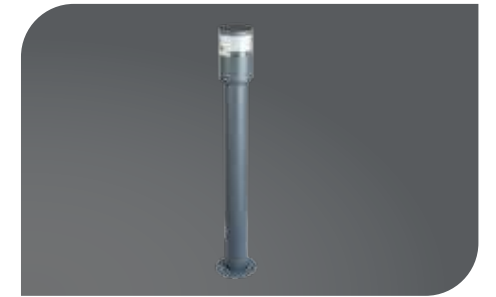

MAYA II

IP65 rated Inverted Pyramid Tripod type LED Bollard with soft 360° light distribution

CAT. REF.	CASE LOT	MRP (₹)
LBLA2-10-CDL	4	5000



MAYA III

Pressure die cast powder coated housing with PC diffuser. Efficient high output LED with IP65 protection

CAT. REF.	CASE LOT	MRP (₹)
LBLA3-10-CDL	4	5300
LBLA3-10-WW	4	5500



BEACON

Step light with IP65 protection for outdoor application

CAT. REF.	CASE LOT	MRP (₹)
CBR-611-06-57-SL-CP-NGG	16	3500
CBR-611-06-30-SL-CP-NGG	16	4000





ALL-IN-ONE STREET LIGHT

SONIVA NEO

Crompton Soniva Neo is an All-In-One solar streetlight with high efficiency mono crystalline solar PV module, LiFePO4 battery with inbuilt BMS technology, MPPT charge controller, aluminum extruded body IP65 with serviceable battery compartment, high efficacy LED >150LPW and PIR dimming provided for optimizing battery autonomy.

CAT. REF.	CASE LOT	MRP (₹)
CSOP-811-15-57-HL5-PIR-LM-SR	1	43200
CSOP-812-15-57-HL5-FD-LM-SR	1	40600
CSOP-813-20-57-HL5-PIR-LM-SR	1	49500
CSOP-814-20-57-HL5-FD-LM-SR	1	47300
CSOP-815-30-57-HL5-PIR-LM-SR	1	58900
CSOP-816-30-57-HL5-FD-LM-SR	1	56300
CSOP-817-40-57-HL4-PIR-LM-SR	1	61000
CSOP-818-40-57-HL4-FD-LM-SR	1	59000
CSOP-821-60-57-HL4-PIR-LM-SR	1	91900
CSOP-822-60-57-HL4-FD-LM-SR	1	89900

SONIVA PRO

Crompton Soniva Pro is an All-In-One solar streetlight with high efficiency mono crystalline solar PV module, LiFePO4 battery with inbuilt BMS technology, MPPT charge controller, aluminum extruded body IP65 with serviceable battery compartment, high efficacy LED >150LPW and PIR dimming provided for optimizing battery autonomy.

CAT. REF.	CASE LOT	MRP (₹)
CSOP-801-15-57-HL5-PIR-LM-GG	1	47100
CSOP-802-15-57-HL5-FD-LM-GG	1	44800
CSOP-803-20-57-HL5-PIR-LM-GG	1	55600
CSOP-804-20-57-HL5-FD-LM-GG	1	53300
CSOP-805-30-57-HL5-PIR-LM-GG	1	64900
CSOP-806-30-57-HL5-FD-LM-GG	1	62800
CSOP-807-40-57-HL4-PIR-LM-GG	1	64800
CSOP-808-40-57-HL4-FD-LM-GG	1	62600
CSOP-811-60-57-HL4-PIR-LM-GG	1	94500
CSOP-812-60-57-HL4-FD-LM-GG	1	92900

Hybrid Solar All-In-One solar lights are available on Request with 10% premium on respective standard models



Solar lighting



SOLAR ALL IN ONE

Crompton Solar All in One consists of high efficacy LEDs, efficient mono crystalline solar panel, new age lithium ferro phosphate battery and a silicon encapsulated high efficiency MPPT Charge controller. It is a uniquely designed aluminium housing device for better heat dissipation with strategically placed perforations. The luminaire also has an in-built PIR Motion sensor.

AUTONOMOUS OPERATIONS

- Significantly lesser dust accumulation
- Saves electricity charges
- Automatic Dusk-Dawn programmed

WIRE-FREE

- Zero cabling
- Components in single housing
- Ease of installation and maintenance
- Saves expenditure

EFFICACY

- Higher luminous efficacy
- More illumination

DURABILITY

- Long life
- Saves expenditure
- Hassle-free usage

SUSTAINABILITY

- Runs on renewable energy
- Helps in carbon-offset mission
- Promotes green energy



1 HOUSING

All Components (LED, Battery, Electronics, Solar Panel) in one housing Aluminium extrusion
 Aesthetically crafted
 Ease of installation & maintenance
 Minimal risk to theft
 Designed for Solar street light application
 Accentuate beautification in area of usage



2 LED

Best Quality LED
 Brighter lighting in areas which were previously dark



3 MPPT CHARGE CONTROLLED (POTTED)

Higher charging efficiency (>93%)
 Protections against deep discharge, over charging, etc
 Automatic dusk-dawn programmed
 Pottling offers IP65 & higher levels of thermal management within the electronics, makes components durable & operate efficiently



4 ENERGY STORAGE

Long life Lithium ferro phosphate battery
 Component level ingress protection



5 MONOCRYSTALLINE SOLAR PANEL

Higher levels of efficiency
 Lesser area required



6 PIR SENSOR

Light management
 Motion based illumination



7 INGRESS PROTECTION

Zero moisture/water
 Component level ingress protection



SOLAR STANDALONE

The Standalone Solar street light generates solar energy from high efficiency Solar PV panels to recharge tubular lead-acid batteries and power high efficacy LEDs. Current/Voltage management is done by high efficiency smart electronics (charge controller). It functions autonomously in charging & discharging capabilities.

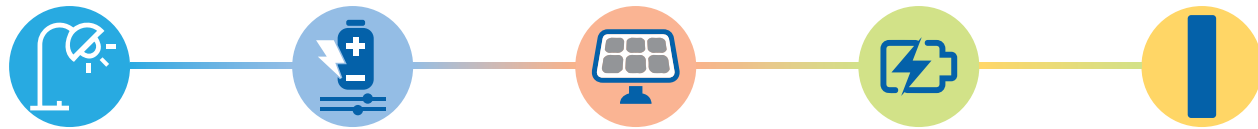

LUMINAIRE

Die-cast aluminium housing, IP65 protected
High power LEDs with efficacy of more than 150lm/W (optional)
Optics for uniform distribution (optional)

CHARGE CONTROLLER

PWM/MPPT based charge controller with high charging efficiency and integrated high efficiency LED driver.
Designed as per IEC standards
Hybrid version with AC backup (optional)

SOLAR PANEL

High efficiency polycrystalline silicon solar cells
Certified as per IEC 61215, IEC 61730, IEC 61701 & MNRE certified

BATTERY

Lithium Ion Batteries - certified as per BIS.
Lithium ferro phosphate batteries - certified as per BIS.

POLE

Tubular/Octagonal
As per IS standards

1 LED

Luminaries specially design for Solar street lighting application with high lumen LED modules for maximum efficiency. Solar controller technology with dimming capabilities for power management.

2 MONO & POLY CRYSTALLINE

Highly efficient mono-and poly-crystalline silicon solar panels.

3 MPPT CHARGE CONTROLLED (POTTED)

Highly efficient charge controller to change the batteries Intelligent microprocessor algorithms automatic determine sunrise and sunset.

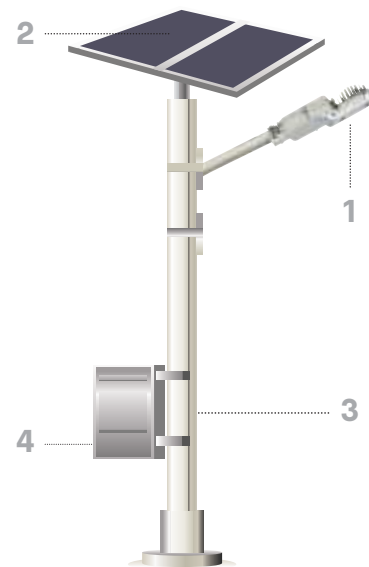

4 ENERGY STORAGE

Available in Tubular / SMF / LMLA. Suitable to frequent cyclic duty. Deep cycle batteries
Corrosion-free IP22 CRCA box, The ventilation system can exchange an adequate amount of fresh air.



HIGH MASTS

Crompton manufactures energy-saving high mast lights that illuminate large areas. These high-performance lights are perfect for golf courses, sports stadiums, oil refineries and busy airports. This lighting solution helps in ensuring pedestrian safety and monitoring places of storage.

Crompton High Mast lighting as a concept in area lighting is increasingly preferred over conventional lighting. This is especially true for large areas where numerous lighting columns can be a hazard to movement. High mast lighting systems achieve very large space to height ratios, providing maximum illumination with the least possible number of lighting columns.

High mast lighting is ideal for many areas, particularly complicated or multi-level road systems, industrial or commercial areas, docks, airports, stations, car parks and even some hazardous areas. All of these areas require the best possible lighting with minimum interference from the installation itself combined with ease of maintenance.

FEATURES

Our high mast is a continuously tapered, polygonal cross section of at least 20 sides, presenting a good and pleasing appearance which is based on proven in tension design conforming to the Technical report no.7 - 1996 of the Institution of Lighting Engineers. UK. to give an assured performance and reliable service. The structure is suitable for loading as per IS 875 (part 3) 1987.

CONSTRUCTION

High mast is fabricated from steel plates conforming to BS-EN 10025, cut and folded to form a polygonal section. Masts are in two sections for 16 & 20 Mtr and in three sections for 25 & 30 Mtr heights having only longitudinal weld conforming to BS 5135/AWS. The mast is provided with a fully penetrated flange which is free from any laminations or incursions. The welded connection of the base flange is fully developed to the strength of the entire section. The base flange is provided with supplementary gussets between bolt holes to ensure elimination of helical stress concentration. For environmental protection of the mast, the entire fabricated mast is Hot Dip Galvanised (Single Dip) internally and externally, having uniform coating thickness of 85 / 65 microns for bottom / top sections respectively.



High Masts & Poles





DOOR OPENING

An adequate door opening is provided at the base of the mast. The opening is such that it permits clear access to equipments like winch, cable, wire rope, plug & socket etc. and also facilitates easy removal of the winch for servicing. The door opening is complete with a close fitting vandal resistant allen key locking with provision for external lock. The door opening is carefully designed and reinforced with adequate steel section so that the mast section at the base is unaffected, and undue buckling of the cut portion is prevented under heavy wind condition.

DYNAMIC LOADING

Our mast structure is designed to sustain an assumed maximum reaction arising from wind speed as per IS 875 (Part 3) 1987 (three seconds) which is measured at a height of 10 mtrs above ground level. Our standard masts are suitable for a wind speed of 180 Kms/hour (50M/Sec) we can also offer masts suitable for a wind speed of 198 kmph and 225 kmph (62.5 M/sec).

ACCESSORIES

The high mast is provided with accessories as per customer requirements. Generally, these include a raising and lowering system (R & L), trailing cable, power tool, feeder pillar for automatic switching operation of luminaires, lighting finial and aviation obstruction warning light. The R & L system will comprise a double drum winch, SS wire ropes, head frame and lantern carriage. The winch is of a self-lubricating and self-sustaining type. It does not require any brake or clutch and has a lifting capacity of SWL 750 Kgs.

The wire ropes are of stainless steel grade AISI316 with minimum 6mm diameter and 7/19 construction. Its central core is also SS and has a breaking strength of 2350Kgs.

The power tool is integral / external type suitable for handling the total head load. It has a mechanical torque limiter to ensure safety, and a manual handle is also provided. It is suitable for use in open areas, airports, railway stations, road junctions, container yards etc.

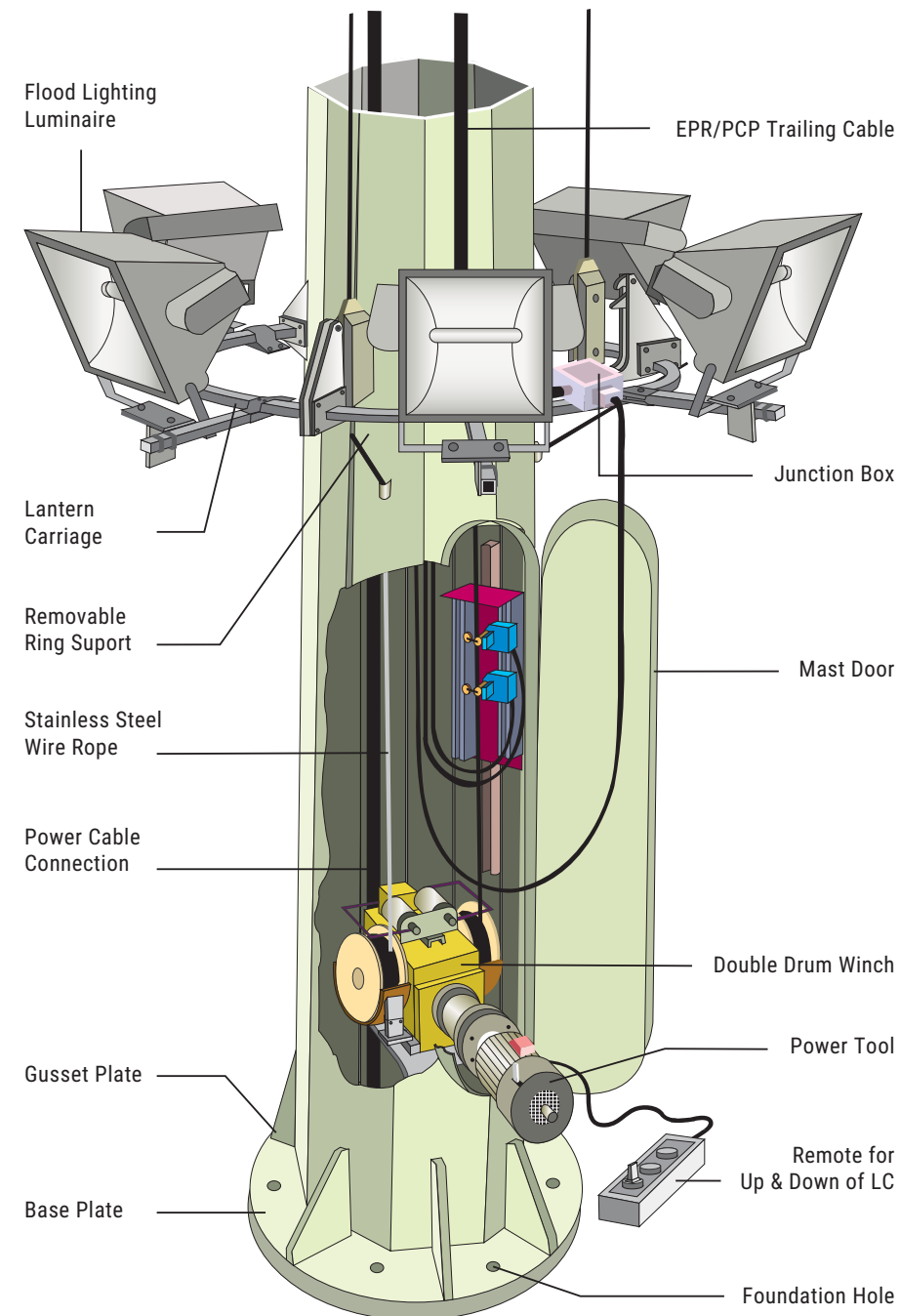

HIGH MAST STRUCTURE

Height of mast (mtrs.)	12.5 Mtr.	16 Mtr.	20 Mtr.	25 Mtr.	30 Mtr.
Material of Construction	BSEN 10025 Equivalent				
Plate Thickness	Top 3 mm - Bottom 3 mm	Top 3 mm - Bottom 4 mm	Top 3 mm - Bottom 4mm	Top 4 mm Middle 4 mm Bottom 5 mm	Top 4 mm Middle 4 mm Bottom 5 mm
Cross Section of Mast	12 Sided Polygon	20 Sided Polygon	20 Sided Polygon	20 Sided Polygon	20 Sided Polygon
Section Leght	Top 6500 - Bottom 6500	Top 8250 - Bottom 8250	Top 10300 - Bottom 10300	Top 8750 Middle 8750 Bottom 8750	Top 10500 Middle 10500 Bottom 10500
Bottom (A/F)	300	360	410	460	600
Top (A/F)	150				
Diameter of Base Plate	520	540	570	670	840
Thickness of Base Plate	25	25	30	30	32

FOUNDATION BOLTS

No. of Foundation Bolt	6	8	8	12	12
PCD of Foundation bolts	445	460	490	590	740
Diameter	M 24	M 30	M 30	M 30	M 30
Length of Foundation Bolts	750	850	850	850	850

LANERN CARRIAGE

No. of Luminaires	6	9	12	12	16
Orientation	Symmetrical				
Number of Joints	2 or 3				
Number of Arms	6	9	6	6	6

DYNAMIC LOADING

Max Design Wind Speed	50 m/s				
Winch / Power Tool Type	Double drum				
SWL of Winch	500 Kg	500 Kg	500 Kg	750 Kg	750 Kg
Method of Operation	Integral Motor				
Motor Capacity	1.5 HP	1.5 HP	1.5 HP	2 HP	2 HP
Torque Limitor	Mechanical				

STAINLESS STEEL WIRE ROPE

Grade	AISI 316				
Construction	7/19				
Number of Ropes	3 Nos of 6 mm for Lantern Carriage, 2 Nos of 6 mm for Double Drum Winch				
Diameter	2 wire rope system for 12.5m HM, 6 mm				
Breaking Load Capacity	2350 Kg				

TRAILING CABLE

Conductor	5 core 2.5 sq mm or 5 core 4 sq mm				
Insulation	Flexible				
No. of Circuits per Mast	One	One	One	One	Two

POWER TOOL

STANDARD ESSENTIAL ACCESSORIES OFFERED WITH HIGH MASTS: Mast shaft, head frame with pullies lantern carriage, luminaire mounting arms (6 nos), 'u' bolts, lighting finial, stainless steel wire ropes 3 nos. for lantern carriage +2 nos for winch, transient plate, double drum winch, power tool, winch & power tool mounting bracket, foundation bolts & nuts, anchor & tem - plate top junction box & LED type aviation light.

OPTIONAL ITEM: • LED type aviation light • Feeder pillar

STREET LIGHTING POLES

With the passage of time the concept of Street lights have under gone a major transformation. From being merely functional elements satisfying illumination requirements during the night time, it now doubles up as street furniture during the day time. The street lighting poles are also contributing immensely to the beauty and character of the changing cityscape. To reduce the clutter on the streets the street lighting poles, today, are also being designed for various street functions.

Crompton offers a wide variety of Hot Dip Galvanised Octogonal poles with a study base plate. Our octagonal poles have a galvanising thickness of 65 microns (internally and externally). This protective coating ensures a long product life and does not require periodic painting. Octagonal poles by Crompton have a distinct edge over conventional round stepped-swedged welded poles.

- Hot dip galvanized (65 microns) internally and externally
- Sleek, elegant and pleasing aesthetics with flushed door
- Bracket design as per customer requirements (on request at extra cost)

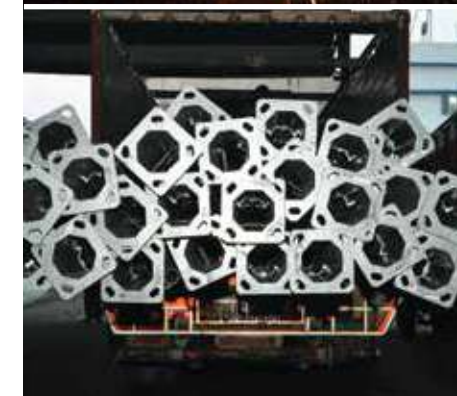

HOT DEEP GALVANIZED POLES

Crompton offers a wide variety of Hot Dip Galvanised Octogonal / Conical poles which can be used for illumination, power distribution and various other application.

These poles are hot dip galvanized after fabrication, internally and externally in accordance with IS-2629 / BSEN ISO 1461 or equivalent. Octagonal poles by Crompton have a distinct edge over conventional round stepped-swedged welded poles.

FEATURE :

- Ease of installation
- Sleek, elegant and pleasing aesthetics. with flushed door.
- Galvanizing reduces the risk of corrosion and maintenance costs.
- Electrically safe with inside cable termination and earth connection.

MATERIAL SPECIFICATION :

The steel galvanized used to manufactured steel poles is as per BSEN 10025 or equivalent.

MOUNTING BRACKET :

Crompton Greaves can supply galvanised arm brackets along with spigots matching with different types of poles and as per customer requirments. Typical arrangement and dimensional details for single arm and double arm bracket along with spigot suitable for different types of poles given here in.



DECORATIVE POLES

CROMPTON CANDLEYA

Steel poles made out of GI pipe section with lower portion of pole made of MS. The poles have diameter 60mm to 90mm at the top. Base is made of 8mm/12mm thick MS sheet with holes suitable for 16mm foundation bolts. The base is so designed that the foundation bolts are not visible.

The poles are painted with multiple coats of weather resistant polyurethane paint. The service window at the lower part of the pole contains connector, cut-outs, MCB.



CROMPTON VOILA

Steel poles made out of GI pipe section with dia cast aluminium embellishments. The poles have diameter 60mm to 90mm at the top and 114mm to 140mm at the bottom. Base is made of die cast MS with holes suitable for 16/20/24 mm foundation bolts.

Pole is pure polyester based powder coated with high corrosion resistance and chemical chromatised protection. Also available with multiple coats of weather resistant Polyurethane paint in various colors. The service window at the lower part of the pole contains connector, cut-outs, MCB.



CROMPTON MAATRA

Steel poles made out of GI pipe section with dia cast iron pedestal. The poles have diameter 60mm at the top and 114mm at the bottom.

Pole is pure polyester based powder coated with high corrosion resistance and chemical chromatised protection. Also available with multiple coats of weather resistant Polyurethane paint in various colors. The service window at the lower part of the pole contains connector, cut-outs, MCB.



CROMPTON TROSSA

Steel poles made out of GI section with cast iron embellishments. The poles have diameter 76mm at the top and 140mm at the bottom. Base is made of die cost iron with holes suitable for 16mm foundation bolts.

Pole is pure polyester based powder coated with high corrosion resistance and chemical chromatised protection. Also available with multiple coats of weather resistant polyurethane paint in various colors. The service window at the lower part of the pole contains connector, cut-outs, MCB.

Grooved Steel Pole

Pole is also available in Grooved GI Sections. The poles have diameter 72mm at the top and 133 mm at the bottom.



CROMPTON BRASSO

Steel poles made out of GI section with cast iron embellishments. The poles have diameter 90mm at the top, diameter 114 in middle and 140mm at the bottom. Base is made of die cost iron with holes suitable for 20mm and 24mm foundation bolts.

Pole is pure polyester based powder coated with high corrosion resistance and chemical chromatised protection. Also available with multiple coats of weather resistant polyurethane paint in various colors. The service window at the lower part of the pole contains connector, cut-outs, MCB.

Grooved Steel Pole

Pole is also available in Grooved GI Sections. The poles have diameter 83mm at the top, diameter 107mm in middle and 133 mm at the bottom.



CROMPTON GLOWEL

Steel poles made out of GI section with cast iron embellishments. The poles have diameter 90mm at the top, diameter 114 in middle and 140mm at the bottom. Base is made of die cost iron with holes suitable for 20mm and 24mm foundation bolts.

Pole is pure polyester based powder coated with high corrosion resistance and chemical chromatised protection. Also available with multiple coats of weather resistant polyurethane paint in various colors. The service window at the lower part of the pole contains connector, cut-outs, MCB.

Grooved Steel Pole

Pole is also available in Grooved GI Sections. The poles have diameter 83mm at the top, diameter 107mm in middle and 133 mm at the bottom.



CROMPTON FRONTERA

Steel poles made out of GI section with cast iron embellishments. The poles have diameter 60mm at the top and diameter 165mm at the bottom. Base is made of die cost MS with holes suitable for 16mm to 24mm foundation bolts.

The poles are painted with multiple coats of weather resistant polyurethane paint. The service window at the lower part of the pole contains connector, cut-outs, MCB.





BRACKETS

Brackets are made out of steel sections of various diameters. Brackets can be made to be mounted on the pole of diameter 60mm/90mm as per requirement. Embellishment are made in MS/Aluminum. The brackets are painted with multiple coats of weather resistant polyurethane paint. Hot dip galvanizing can be done on the complete bracket on request.

SINGLE ARM

WALL



DOUBLE ARM



SINGLE ARM



DOUBLE ARM



SINGLE ARM



DOUBLE ARM



SINGLE ARM

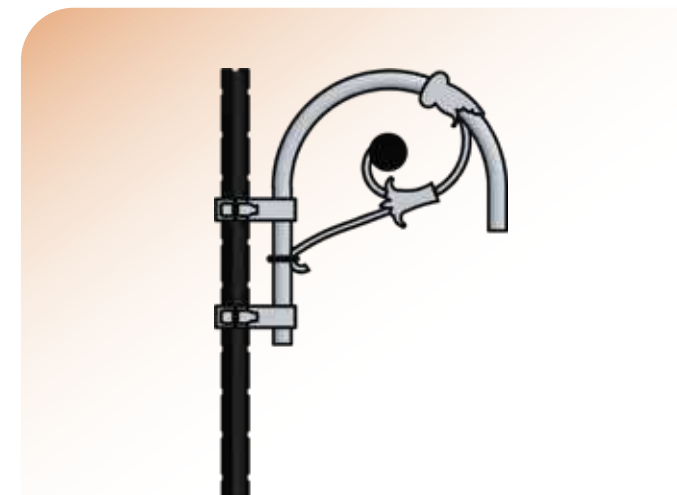

DOUBLE ARM

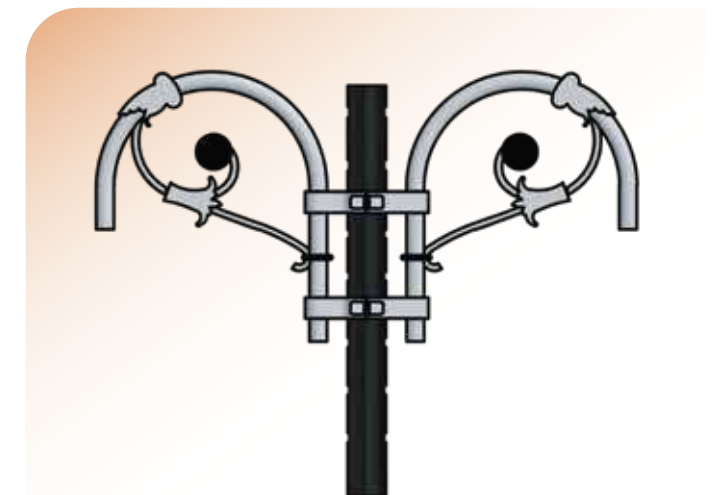

SINGLE ARM



DOUBLE ARM



SINGLE ARM



DOUBLE ARM



SINGLE ARM

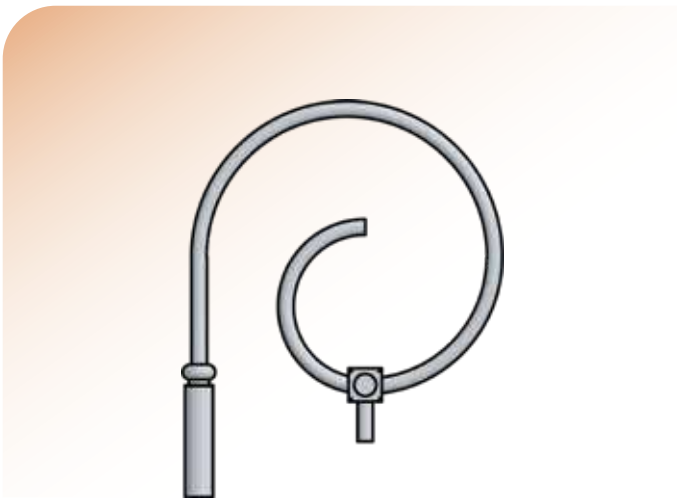

DOUBLE ARM

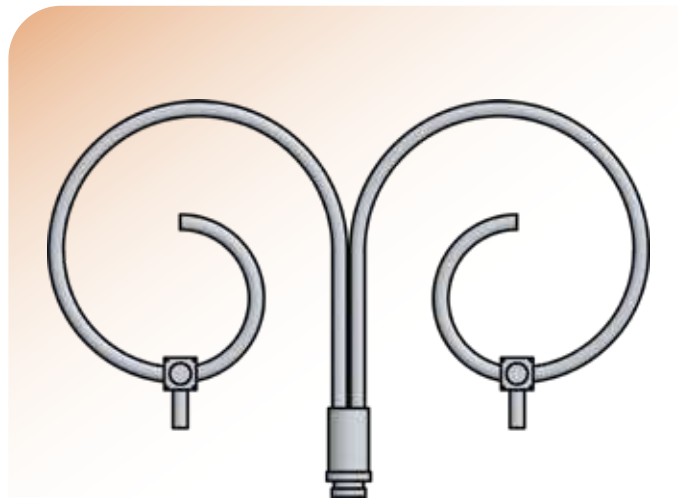

SALES OFFICES

Branch	Phone/Mobile No.
EAST REGION : LightingB2B-Kolkata-RO@crompton.co.in	
Kolkata : 52, Chowringhee Road, 5th Floor, Kolkata - 700071, India.	9830533999
Guwahati : 3rd Floor, Shubham Velocity, Hanuram Boro Path Walford, GS Road, Guwahati, Assam- 781005.	9678085875
Bhubaneswar : Plot No- A/2, Near Aangan Restaurant, Saheed Nagar, Bhubaneswar, Odisha- 751007.	7381020369
Ranchi : ESS Agencies 3 West End Park, Kaju Bagan, Near Dav Junior School, Hehal Ratu Road, Ranchi - 834005, Jharkhand.	8249662635
Patna : 3rd Floor, Shri Sadan, House No. 9, Opp. Ruban Hospital, Near Patliputra Golamber, Patliputra Colony, Patna - 800013, Bihar.	8407074981
WEST REGION : LightingB2B-Mumbai-RO@crompton.co.in	
Mumbai : A-Wing, 302, 3rd floor, Chakala, Opp Apple Heritage, Andheri-Kurla Road, Andheri East, Mumbai - 400093.	9833246665
Ahmedabad : 4th Floor, 405 Gala Argos, BH Gujarat College, Ahmedabad - 380007 Gujarat.	7665566667 / 9099924867
Pune : Durwankur Apartment, Wrangler Paranjape Road, Behind Vaishali Hotel, FC Road, Pune - 411004 Maharashtra.	9167540712
Indore : 409, 4th Floor, Satguru Parinay, Infront of C21 Mall, A .B. Road, Indore - 452010 M.P.	9713244447
Nagpur : 2nd Floor, Manik Bhawan, Plot No. 7&8, Taty Tope Nagar, West High Court Road, Nagpur - 440015 Maharashtra.	9766915561
Raipur : A-311, Crystal Arcade, Lodhi Para Square, Shankar Nagar, Raipur - 492007.	9329693048
NORTH REGION : LightingB2B-NewDelhi-RO@crompton.co.in	
New Delhi : 9-10 Bahadur Shah Zafar Marg, 3rd Floor, Express Building, Near ITO Crossing. New Delhi - 110002.	9650017119 / 9654125384 9990016161
Jaipur : Centre Point, 3rd Floor, Bhragu Nagar, Above Indusind Bank, DCM, Ajmer Road, Jaipur - 302006.	7665566667
Jalandhar : Bxii-407, 2nd Floor, Near B.S.F. Chowk, Ladowali Road, Jalandhar - 144001.	0181-5044240 9888748383
Lucknow : Cyber Height, 2nd Floor, Office Space No.210, Vibhuti Khand, Gomti Nagar, Lucknow - 226010.	9807279777 9953626622
SOUTH REGION : LightingB2B-Chennai-RO@crompton.co.in	
Chennai : Crompton Greaves Consumer Electricals Limited, No. 4 (New), Old No. 5, Kanniah Street, T.Nagar, Chennai - 600028.	9962583100
Coimbatore : SF219, Annamalai Industrial Park, Kalapatti, Coimbatore - 641048.	9842719055
Visakhapatnam : Flat No. 101, Gokul Complex, Nowroji Road, Maharani Peta, Visakhapatnam - 530002.	9642000224
Bengaluru : J. P. Square, 3rd Floor, No.17, 3rd Cross, 5th Main, Chamrajpet, Bengaluru - 560018.	8884255123
Hyderabad : No. 101 & 102, Babukhan Millennium Centre, Somajiguda, Hyderabad - 500082.	9885785757
Vizag : Flat No: 101, Gokul Complex, Nowroji Road, Maharani Peta, Visakhapatnam - 530002.	9642000224
Cochin : Door No. 3/5788, Zera Tower Cheranallore, Cochin - 682034.	9744041000

TERMS AND CONDITIONS :

- The Company reserves the right to revoke, modify, add and delete any of the terms and conditions outlined in the brochure. The Company shall be under no obligation to notify the user of the amendment to the terms and conditions and the user shall be bound by such amended terms and conditions.
- Computer generated and render images used on this brochure are the artist's impression and are an indicative of the actual designs. The imagery used on the brochure are produced internally and may not represent actuals or may be indicative of style only.
- This brochure may unintentionally include inaccuracies or errors with respect to the description of product features, specification, product photo or design guidelines. Further the actual design may vary in fit and finish from the one displayed in the information and material displayed on this brochure.
- The user must verify all the details and specifications, including but not limited to the product features, specifications, product availability, and all other relevant terms independently with our sales and marketing team prior to concluding any decision for buying.
- While enough care is taken by the Company to ensure that information in the brochure are up to date.